

# COMPRESSEURS D'AIR

Air compressors

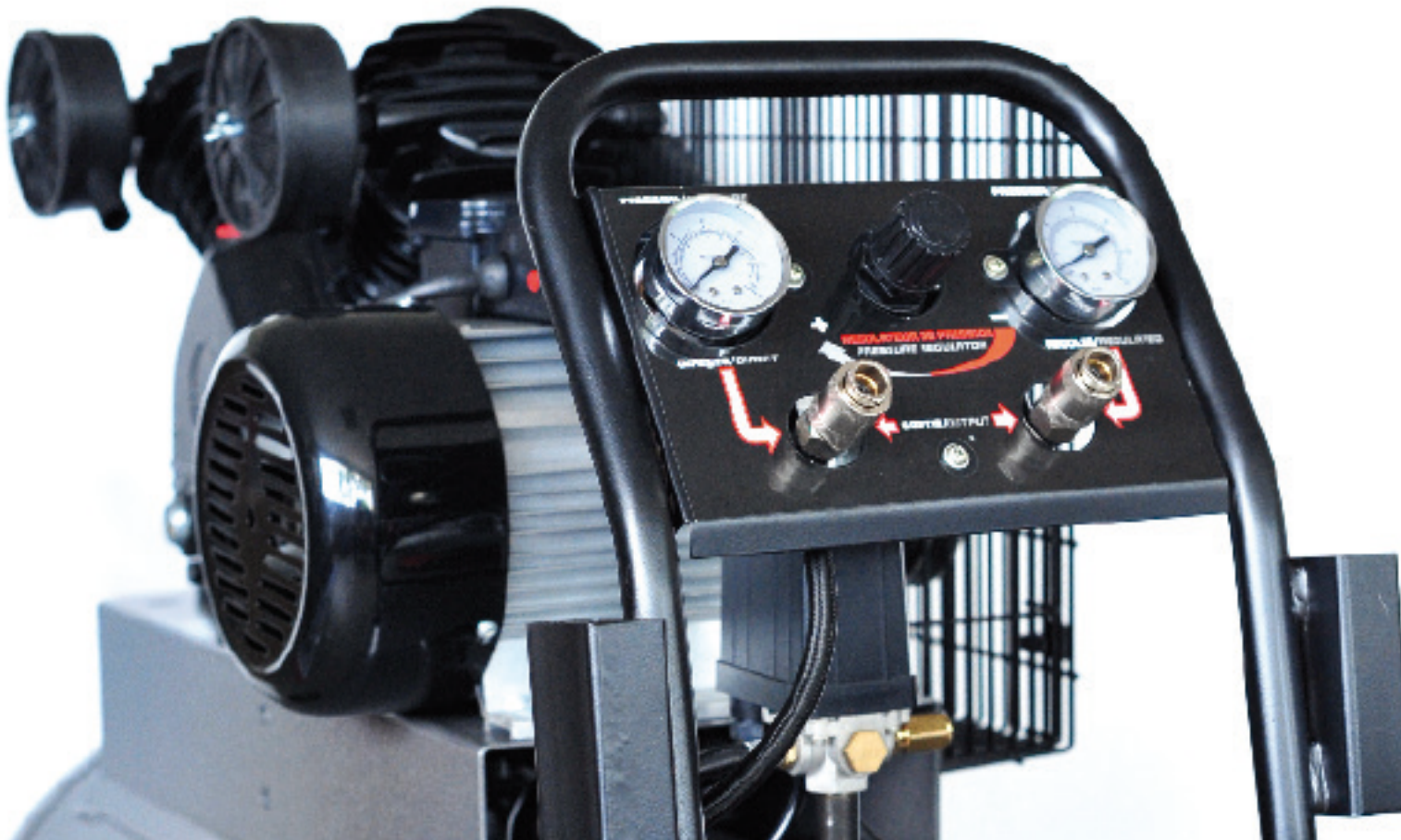

Gamme TRE TRE Range

# Compresseurs d'air

Air compressors

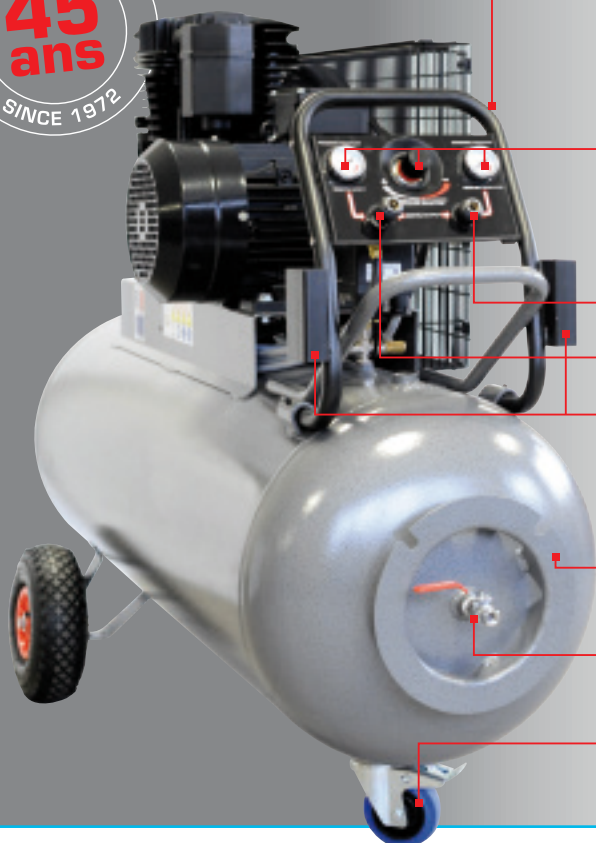

- **Maniabilité accrue / Increased handling**
  - **Grosses roues / Inflated tyres**
  - **Roulette pivotante / Swivel wheel**
  - **Poignée de transport en position haute / High-positioned handle for transportation**
- **Nouveau tableau de bord / New panel board**
  - **Lecture parfaite des informations / Easy-to-read instructions**
  - **Réglages facilités / Easy adjustments**
- **Sortie d'air directe / Direct air outlet**
- **Sortie d'air détendue / Regulated air outlet**
- **Fourreaux pour rangement accessoires / Storage compartments (pour poignée de gonflage, pistolet à peinture...)/ (for blow gun, inflating gun, spray gun)**
- **Moyeu de rangement pour tuyau / Storage hub for air hose**
- **Vanne sortie d'air directe (sur 150L et plus) / Direct air outlet ball valve (for 150L and more)**
- **Roulette renforcée avec frein (sur 150L et plus) / Reinforced castor wheel with brake (for 150L and more)**



**Tous nos produits sont en conformité avec les normes européennes en vigueur.**  
All our products are manufactured according to the European regulations.



**Notre service qualité veille au suivi et à l'amélioration de nos produits.**  
Our quality department takes closely care of our products and their improvements.



**Tous nos produits sont essayés et testés en configuration finale avant expédition.**

All our products are tested in their final configuration before dispatch.



**Fabrication française.**  
Made in France.



## Symboles

Symbols



**Capacité du réservoir**  
Tank capacity



**Nombre de pistons**  
Number of pistons



**Volume d'air restitué**  
Air delivery



**Puissance du moteur**  
Motor power



**Nombre d'étages**  
Number of stage



**Poids net**  
Net weight



**Tension d'alimentation**  
Power supply



**Pression maximum en Bar**  
Maximum pressure



**L x l x H**  
Dimensions



**Tours par minute**  
Revolutions per minute



**Volume d'air engendré**  
Air intake

# Compresseurs à entraînement direct

Direct driven air compressors

50 L / 2,5 - 3,5 CV

50 L / 2,2 - 3,5 HP

TRE1105025GJ

⚡ 230/1

50 L

2,5 HP

🌀 135 L/min



TRE1205035G











⚡ 230/1

50 L

3,5 HP

🌀 290 L/min



Références											L x l x H
TRE1105025GJ	50	2,5	230/1	2950	1	1	8	230	135	33	80 x 45 x 69
TRE1205035G	50	3,5	230/1	2960	2	1	8	370	290	39	78 x 50 x 67

# Compresseurs à courroie

Belt air compressors

50 - 100 L / 3 CV

50 - 100 L / 3 HP

TRE2205030MG

⚡ 230/1

50 L

3 HP

🌬️ 270 L/min



TRE2210030MG

⚡ 230/1

TRE2210030TG











⚡ 400/3

100 L

3 HP

🌬️ 270 L/min



Références											L x l x H
TRE2205030MG	50	3	230/1	1140	2	1	9	347	270	65	82 x 49 x 76
TRE2210030MG	100	3	230/1	1140	2	1	9	347	270	70	104 x 50 x 80
TRE2210030TG	100	3	400/3	1140	2	1	9	347	270	70	104 x 50 x 80

# Compresseurs à courroie

Belt air compressors

150 - 200 L / 3 CV

150 - 200 L / 3 HP

TRE2214030MG

⚡ 230/1

TRE2214030TG

⚡ 400/3

150 L

3 HP

310 L/min



TRE2220030MG

⚡ 230/1

TRE2220030TG

⚡ 400/3

200 L

3 HP

310 L/min



Références											L x l x H
TRE2214030MG	150	3	230/1	1243	2	1	9	380	310	91	138 x 60 x 96
TRE2214030TG	150	3	400/3	1243	2	1	9	380	310	94	138 x 60 x 96
TRE2220030MG	200	3	230/1	1243	2	1	9	380	310	108	150 x 60 x 102
TRE2220030TG	200	3	400/3	1243	2	1	9	380	310	111	150 x 60 x 102

# Compresseurs à courroie

Belt air compressors

200 L / 5,5 CV  
200 L / 5,5 HP

TRE2320055TG

⚡ 400/3

200 L

5,5 HP

🌀 450 L/min



TRE2220055TG











⚡ 400/3

200 L

5,5 HP

🌀 492 L/min



Références											L x l x H
TRE2320055TG	200	5,5	400/3	1181	3	1	9	585	450	127	150 x 60 x 108
TRE2220055TG	200	5,5	400/3	1400	2	2	11	578	492	127	150 x 60 x 124