

AGENCEMENT





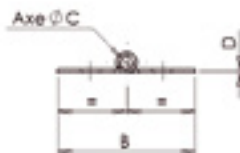
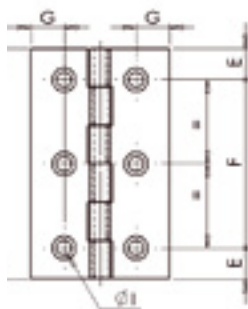

CHARNIÈRES
HINGES

9.1 CHARNIÈRES

1001 | Charnière rectangulaire à nœud roulé A.D. percée fraisée





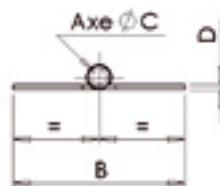
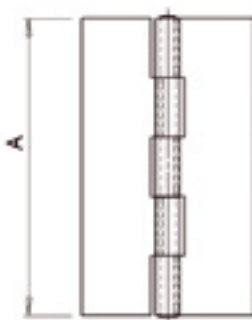
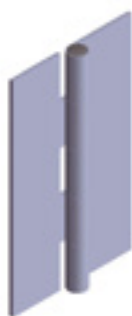

REF.	AxB	C	D	E	F	G	I	 mm	 mm	 Kg 100 p.	
421 010	*20x16	1,8	0,4x2	4,2	11,6	3,2	2	1,5	4	0,26	50
421 030	*25x18	1,8	0,4x2	5	15	3,7	2,3	2	4	0,36	50
421 050	30x19	2,4	1	5,5	19	4	2,7	2	4	0,54	50
421 070	35x22	2,4	0,8	6,5	22	4	3,2	2	4	0,74	50
421 090	40x25	2,4	1	6,5	27	4,5	3,6	3	4	1,12	50
421 110	50x30	2,4	1	7,5	35	7	3,9	3	4	1,6	25
421 130	60x35	3,5	1	8	44	8,8	3,9	3	6	2,3	25
421 150	70x40	3,5	1	9	52	8,7	4,5	3,5	6	4	25
421 170	80x45	3,5	1	10,5	59	9,6	4,6	3,5	6	4,9	25
421 190	90x50	3	1	11	68	10	4,6	3,5	6	4,8	25
421 200	100x50	5	1,5	11,5	77	9,7	4,5	4	6	8,9	25

Cotes en mm / * Livraison en double feuille

1001 | Charnière rectangulaire à nœud roulé A.D. non percée / en vrac





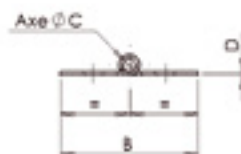
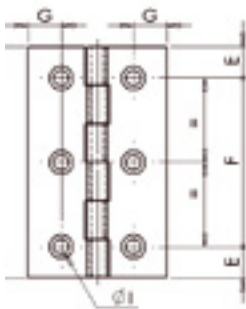

REF.	AxB	C	D	E	F	G	I	 mm	 mm	 Kg 100 p.	
421 250	30x19	2,4	0,8							0,54	3200
421 270	35x22	2,4	0,8							0,74	3000
421 310	50x30	2,4	1							1,6	1000
421 330	60x35	3	1							2,3	500
421 350	70x40	4	1,2							4	600
421 400	100x50	5	1,5							8,9	200

Cotes en mm / Produit spécial, nous consulter

1001 | Charnière rectangulaire à nœud roulé A.Z. percée fraisée





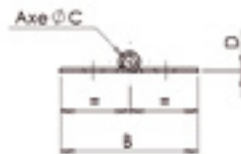
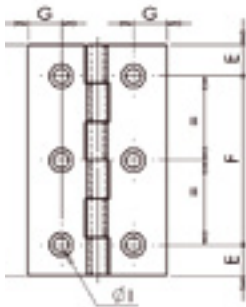

REF.	AxB	C	D	E	F	G	I	 mm	 mm	 Kg 100 p.	 P
421 410	*20x16	1,8	0,4x2	4,2	11,6	3,2	2	1,5	4	0,26	50
421 430	*25x18	1,8	0,4x2	5	15	3,7	2,3	2	4	0,36	50
421 450	30x19	2,4	1	5,5	19	4	2,7	2	4	0,54	50
421 470	35x22	2,4	0,8	6,5	22	4	3,2	2	4	0,74	50
421 490	40x25	2,4	1	6,5	27	4,5	3,6	3	4	1,12	50
421 510	50x30	2,4	1	7,5	35	7	3,9	3	4	1,6	25
421 530	60x35	3,5	1	8	44	8,8	3,9	3	6	2,3	25
421 550	70x40	3,5	1	9	52	8,7	4,5	3,5	6	4	25
421 570	80x45	3,5	1	10,5	59	9,6	4,6	3,5	6	4,9	25
421 590	90x50	3,5	1	11	68	10	4,6	3,5	6	4,8	25
421 600	100x50	5	1,5	11,5	77	9,7	4,5	4	6	8,9	25

Cotes en mm / * Livraison en double feuille

1001 | Charnière rectangulaire à nœud roulé A.L. percée fraisée







REF.	AxB	C	D	E	F	G	I	 mm	 mm	 Kg 100 p.	 P
422 010	*20x16	1,8	0,4x2	4,2	11,6	3,2	2	1,5	4	0,26	50
422 030	*25x18	1,8	0,4x2	5	15	3,7	2,3	2	4	0,36	50
422 050	30x19	2,4	1	5,5	19	4	2,7	2	4	0,54	50
422 070	35x22	2,4	0,8	6,5	22	4	3,2	2	4	0,74	50
422 090	40x25	2,4	1	6,5	27	4,5	3,6	3	4	1,12	50
422 110	50x30	2,4	1	7,5	35	7	3,9	3	4	1,6	25
422 130	60x35	3,5	1	8	44	8,8	3,9	3	6	2,3	25
422 150	70x40	3,5	1	9	52	8,7	4,5	3,5	6	4	25
422 200	100x50	5	1,5	11,5	77	9,7	4,5	4	6	8,9	25

Cotes en mm / * Livraison en double feuille

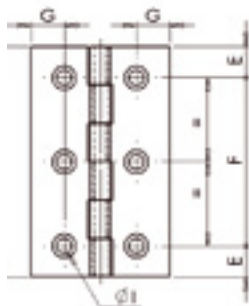
9.1 CHARNIÈRES

1001 | Charnière rectangulaire à nœud roulé LAITON percée fraisée





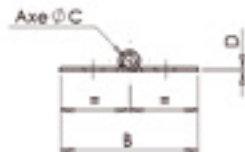
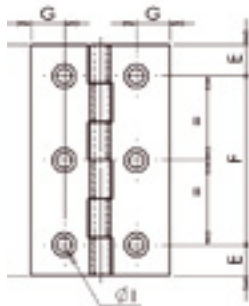

REF.	AxB	C	D	E	F	G	I	 mm	 mm	 Kg 100 p.	
422 410	*20x16	1,8	0,4x2	4,2	11,6	3,2	2	1,5	4	0,26	50
422 430	*25x18	1,8	0,4x2	5	15	3,7	2,3	2	4	0,4	50
422 450	30x19	2,4	0,8	5,5	19	4	2,7	2	4	0,57	50
422 470	35x22	2,4	0,8	6,5	22	4	3,2	2	4	0,78	50
422 490	40x25	2,7	0,9	6,5	27	4,5	3,2	3	4	1,23	50
422 510	50x30	2,7	0,9	7,5	35	6,5	3,5	3	4	1,65	25
422 530	60x35	3,5	1	8	44	8,8	3,9	3	6	2,42	25
422 550	70x40	3,5	1	9	52	8,7	4,5	3,5	6	4,2	25
422 570	80x45	3,5	1	10,5	59	9,6	4,6	3,5	6	5,15	25
422 590	90x50	4,5	1,5	11	68	9,7	4,5	4	6	8,1	25
422 600	100x50	5	1,5	11,5	77	9,7	4,5	4	6	9,5	25

Cotes en mm / * Livraison en double feuille

1001 | Charnière rectangulaire à nœud roulé INOX percée fraisée





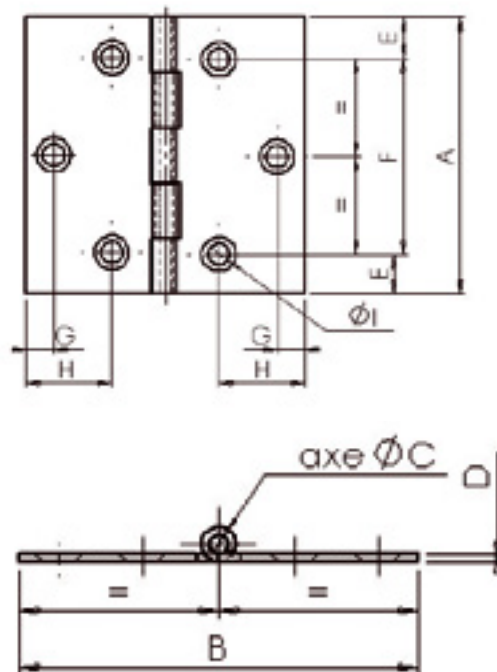
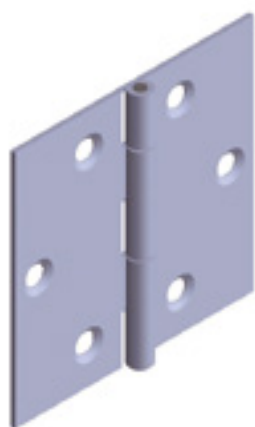

REF.	AxB	C	D	E	F	G	I	 mm	 mm	 Kg 100 p.	
422 750	30x19	2,4	0,8	5,5	19	4	2,7	2	4	0,6	50
422 770	35x22	2,4	0,8	6,5	22	4	3,2	2	4	0,8	50
422 790	40x25	2,7	0,9	6,5	27	4,5	3,2	3	4	1,14	50
422 810	50x30	2,7	0,9	7,5	35	6,5	3,5	3	4	1,65	25
422 830	60x35	3	1	8	44	8	3,6	3	6	2,4	25
422 850	70x40	4	1,2	9	52	8	4	3,5	6	4,08	25
422 870	80x45	4	1,2	10,5	59	9	4,5	3,5	6	5	25
422 890	90x50	4,5	1,5	11	68	9,7	4,5	4	6	7,9	25
422 900	100x50	5	1,5	11,5	77	9,7	4,5	4	6	8,9	25

Cotes en mm

1002 | Charnière carrée à nœud roulé A.D. percée fraisée







REF.	AxB	C	D	E	F	G	H	I	 mm	 mm	 Kg 100 p.	
423 050	30x30	2,4	1	5,5	19		6,35	3,1	2	4	0,95	50
423 070	40x40	2,4	1	6	28	5,4	12	3,7	2,5	6	1,5	50
423 090	50x50	2,4	1	7,5	35	6,5	15	3,9	2,5	6	2,1	25
423 110	60x60	3	1	8	44	7	20	3,6	3	6	3,42	25
423 130	70x70	4	1,2	9	52	8	23	3,8	3	6	5,9	25
423 150	80x80	4	1,2	10,5	59	8,5	26	4,5	4	6	7,4	25
423 170	90x90	4,5	1,5	11	68	12	24	5	4	6	11,7	25
423 190	100x100	5	1,5	11,5	77	12	33	5,4	4,5	6	14,8	25

Cotes en mm

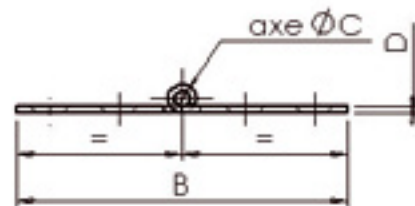
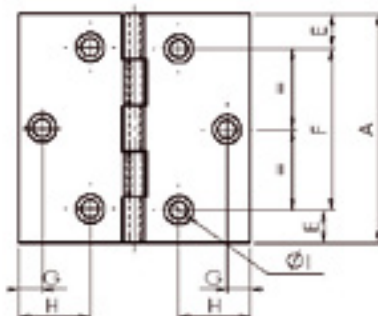
9.1 CHARNIÈRES

1002 | Charnière carrée à nœud roulé A.Z. percée fraisée





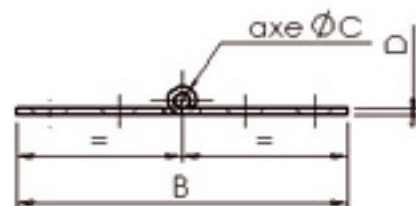
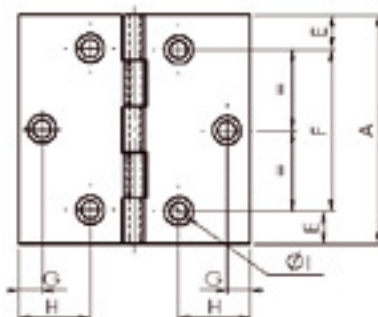

REF.	AxB	C	D	E	F	G	H	I	 mm	 mm	 Kg 100 p.	
423 450	30x30	2,4	1	5,5	19		6,35	3,1	2	4	0,95	50
423 470	40x40	2,4	1	6	28	5,4	12	3,7	2,5	6	1,5	50
423 490	50x50	2,4	1	7,5	35	6,5	15	3,9	2,5	6	2,1	25
423 510	60x60	3	1	8	44	7	20	3,6	3	6	3,42	25
423 530	70x70	4	1,2	9	52	8	23	3,8	3	6	5,9	25
423 550	80x80	4	1,2	10,5	59	8,5	26	4,5	4	6	7,4	25
423 570	90x90	4,5	1,5	11	68	12	24	5	4	6	11,7	25
423 590	100x100	5	1,5	11,5	77	12	33	5,4	4,5	6	14,8	25

Cotes en mm

1002 | Charnière carrée à nœud roulé INOX percée fraisée





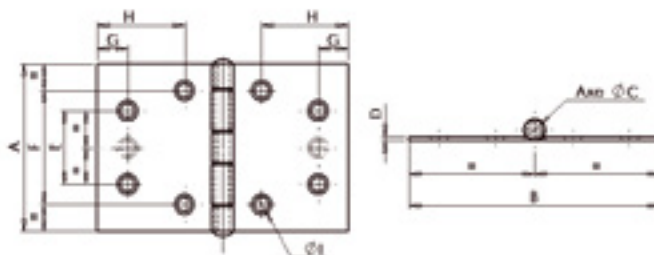
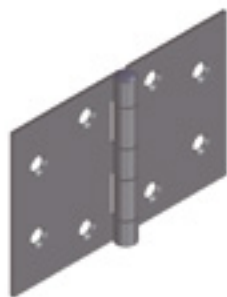

REF.	AxB	C	D	E	F	G	H	I	 mm	 mm	 Kg 100 p.	
423 710	30x30	2,4	0,8	5	20		6,3	2,8	2	4	0,97	50
423 730	40x40	2,7	1	6	28	5,5	12	3,6	2,5	6	1,61	50
423 750	50x50	2,7	0,9	7,5	35	6,5	15	3,6	2,5	6	2,46	25
423 770	60x60	3	1	8	44	7	20	3,6	3	6	3,49	25
423 790	70x70	4	1,2	9	52	8	23	4	3	6	6,1	25
423 810	80x80	4	1,2	10,5	59	8,5	26	4,5	4	6	7,7	25
423 830	90x90	4,5	1,5	11	68	12	24	5	4	6	11,94	25

Cotes en mm

1006 | Charnière à nœud roulé A.Z. percée fraisée





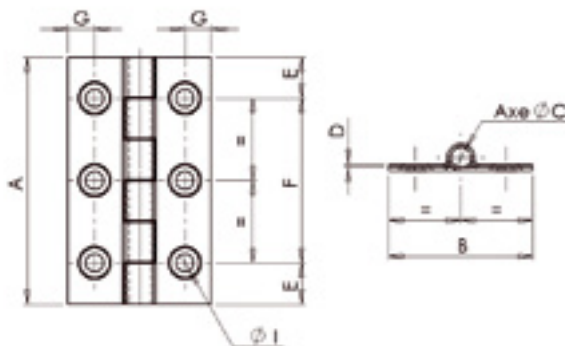

REF.	AxB	C	D	E	F	G	H	I	 mm	 mm	 Kg 100 p.	
423 950	50x75	4	1,2	22	34	9	26	4,2	3,5	8	4,7	25
423 970	60x90	4	1,5	42	34	10	29	4,2	3,5	8	7,8	25

Cotes en mm

1003 | Charnière rectangulaire forte double feuille A.D. «Bordelaise» Percée fraisée / gros nœud







REF.	AxB	C	D	E	F	G	I	 mm	 mm	 Kg 100 p.	
424 010	50x30	3,5	0.8x2	9	32	5,5	3,7	3	4	2,22	25
424 030	60x40	5	0.8x2	10	40	7	4,4	4	6	3,84	25
424 040	70x40	5	0.8x2	10	50	7	4,4	4	6	4,5	25
424 050	70x50	5	0.8x2	10	50	12	4,4	4	6	5,41	25
424 060	80x45	5,7	1x2	10	60	8	4,4	4	6	7,21	25
424 070	80x50	5,7	1x2	10	60	10,5	4,4	4	6	7,75	25
424 080	80x60	5,7	1x2	10	60	16,5	4,4	4	6	9,07	25
424 090	90x50	5,7	1.2x2	10	70	8,5	4,4	4	6	10,26	25
424 100	100x50	5,7	1.2x2	10	80	10	4,4	4	6	11,4	25

Cotes en mm

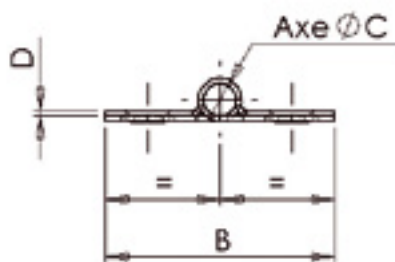
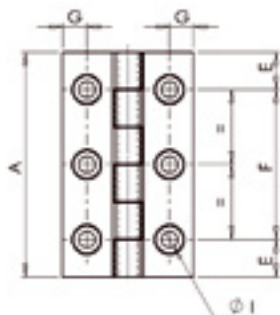
9.1 CHARNIÈRES

1011 | Charnière rectangulaire forte double feuille A.Z. «Havraise» Percée fraisée





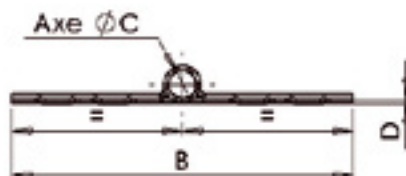
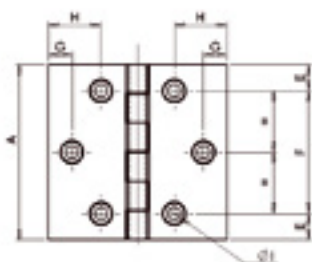

REF.	AxB	C	D	E	F	G	H	I	 mm	 mm	 Kg 100 p.	
427 050	60x40	5	0.8x2	10	40	7		4,4	4	6	3,84	25
427 060	70x50	5	0.8x2	10	50	12		4,4	4	6	5,41	25
427 070	80x45	5,7	1x2	10	60	8		4,4	4	6	7,21	25
427 080	80x60	5,7	1x2	10	60	16,5		4,4	4	6	9,07	25

Cotes en mm / * Voir 1011 carrée

1004 | Charnière carrée forte double feuille A.D. «Bordelaise» Percée fraisée / gros nœud





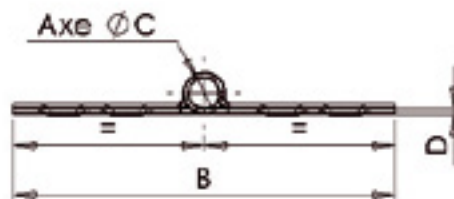
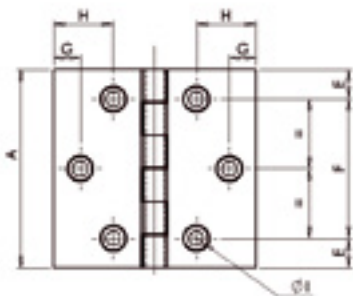

REF.	AxB	C	D	E	F	G	H	I	 mm	 mm	 Kg 100 p.	
424 320	50x50	3,6	0.8x2	9	32	7,5	15,5	3,6	3	6	3,4	25
424 330	60x60	5	0.8x2	9	42	8	18	4,4	4	6	5,43	25
424 340	70x70	5	0.8x2	9	52	10	21	4,4	4	6	7,11	25
424 350	80x80	5,7	1x2	10	60	16,5	25	4,4	4	6	11,57	25
424 370	100x100	5,7	1.2x2	12	70	13	30	4,4	4	6	20,66	25

Cotes en mm

1011 | Charnière carrée forte double feuille A.Z. «Havraise» Percée fraisée





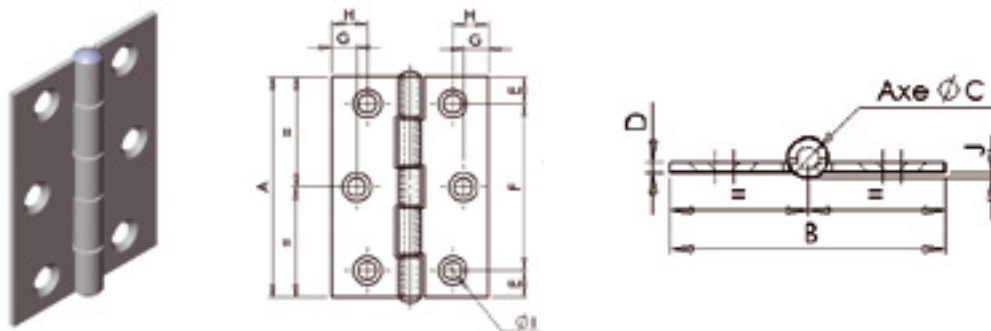

REF.	AxB	C	D	E	F	G	H	I	 mm	 mm	 Kg 100 p.	
427 120	70x70	5	0.8x2	9	52	10	21	4,4	4	6	7,11	25
427 130	80x80	5,7	1x2	10	60	16,5	25	4,4	4	6	11,575,41	25

Cotes en mm

I 1005 | Charnière forte à nœud roulé A.Z. Percée fraisée / gros nœud





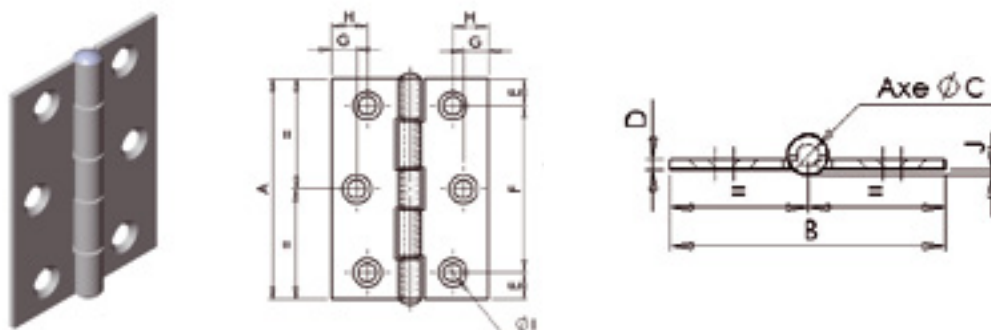

REF.	AxB	C	D	E	F	G	H	I	J	 mm	 mm	 Kg 100 p.	
425 010	50x38	3	1,5	7,5	35		7,6	4,5	1	3,5	4	2,8	25
425 020	63x44	3,5	1,5	7,5	47	7	10	5,2	1	4	6	4,06	25
425 030	75x50	4	2	9,8	55,4	7,5	11	5,7	1	4,5	6	7,49	25
425 040	88x58	5	2	10,5	66	8,5	14	6,7	1	4,5	6	10,73	25
425 050	102x72	6	2	10,5	81	8,5	15,5	6,7	1	4,5	8	15,47	25

Cotes en mm

I 1005 | Charnière forte à nœud roulé INOX Percée fraisée / gros nœud



REF.	AxB	C	D	E	F	G	H	I	J	 mm	 mm	 Kg 100 p.	
425 210	50x38	3	1,5	7,5	35		7,6	4,5	1	3,5	4	2,86	25
425 220	63x44	3,5	1,5	7,5	47	7	10	5,2	1	4	6	4,15	25
425 230	75x50	4	2	9,8	55,4	7,5	11	5,7	1	4,5	6	7,64	25
425 240	88x58	5	2	10,5	66	8,5	14	6,7	1	4,5	6	10,95	25
425 250	102x72	6	2	10,5	81	8,5	15,5	6,7	1	4,5	8	15,78	25

Cotes en mm

9.1 CHARNIÈRES

2001 | Charnière « Américaine » à nœud roulé A.D. broche mobile / non percée

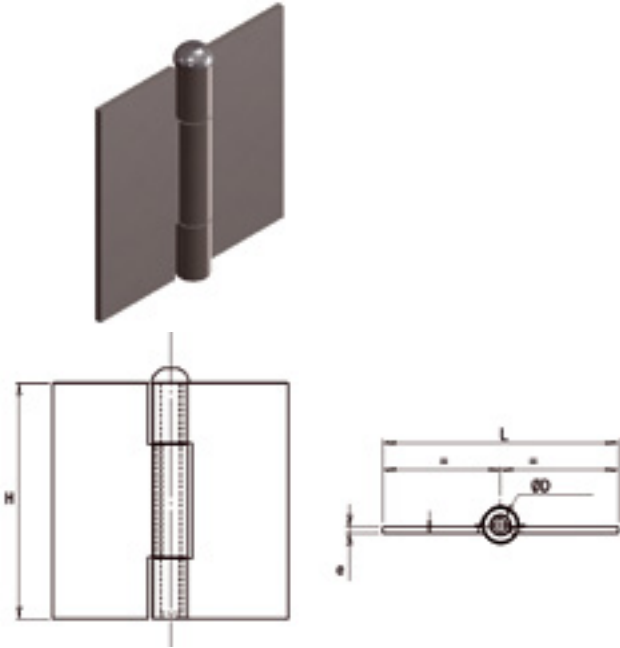

REF.	AxB	C	D	J	Kg 100 p.	
425 410	40x40	4	2	1,5	3,6	25
425 420	50x50	6	2	2,5	6,4	25
425 430	60x60	6	2	2,5	8,5	25
425 440	70x70	6	2	2,5	10,8	25
425 450	80x80	6	2,5	2,5	16,8	25
425 460	100x100	6	2,5	2,5	24,9	25

Cotes en mm

2001 | Charnière « Américaine » à nœud roulé A.Z. broche mobile / percée fraisée

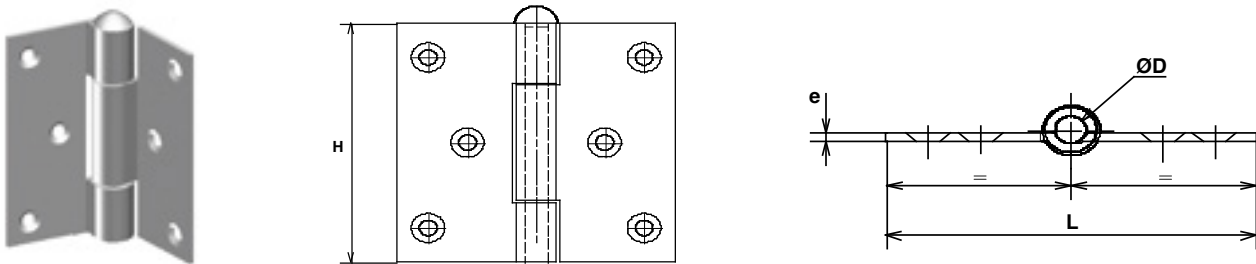

REF.	AxB	C	D	E	F	G	H	I	J		Σ mm	Kg 100 p.	
425 610	40x40	4	2	8	24	7		4,2	1,5	3,5	4	3,5	25
425 620	50x50	6	2	8	34	8		4,2	2,5	3,5	4	6,2	25
425 630	60x60	6	2	10,25	39,5	8,2		4,2	2,5	3,5	4	8,4	25
425 640	70x70	6	2	10	50	8	18,5	4,2	2,5	3,5	6	10,5	25
425 650	80x80	6	2,5	10	60	8,5	20,5	4,2	2,5	3,5	6	16,4	25

Cotes en mm

Charnière d'équerre débrochable A.N. Haut. 40 mm

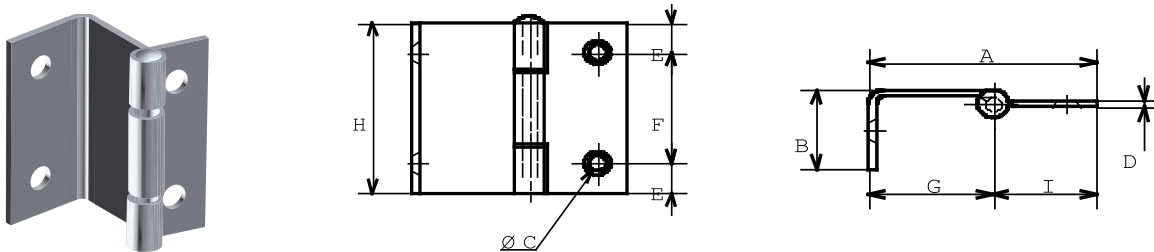

REF.	DÉSIGNATION	AxB	C	D	E	F	G	H	I		Σ mm	Kg 100 p.	
426030	Pour porte épaisseur 16 mm	39x17	4,5	1,5	7	26	21	40	18	3,5	4	3,3	20
426130	Pour porte épaisseur 18 mm	44x17.5	3,8	1,5	7	26	24	40	20	3	4	3,5	20

Cotes en mm

1015 | Charnière de table simple feuille A.D. percée fraisée

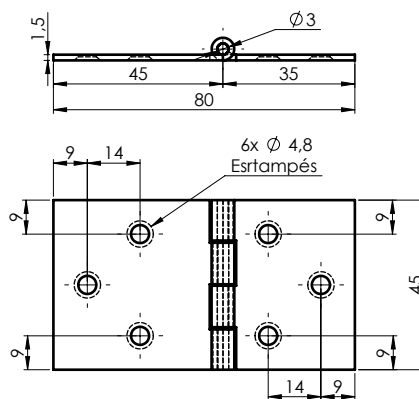

REF.	AxB	Kg	100 p.	P
426 370	45x80	5	50	

Cotes en mm

1015 | Charnière de table double feuille A.D. percée fraisée

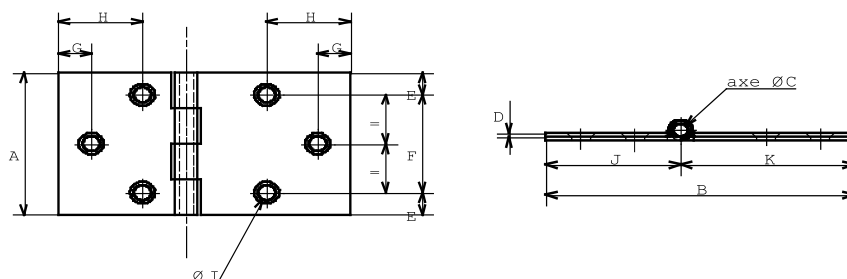

REF.	AxB	C	D	E	F	G	H	I	J	K	mm	mm	Kg	100 p.	P
426 410	45x80	4	1x2	9	27	9	23	4,7	35	45	4	6	5,9	50	
426 430	50x85	4	1x2	9	32	9	25	4,7	37,5	47,5	4	6	6,7	50	

Cotes en mm

3005 | Charnière festonnée à nœud roulé percée fraisée

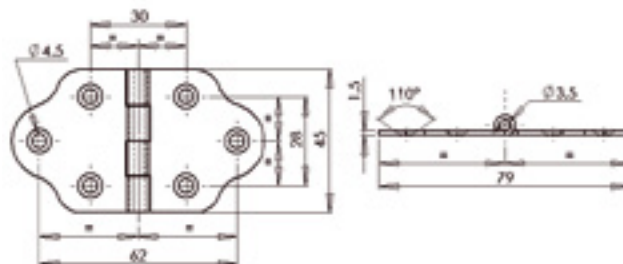



REF.	FINITION	AxB	Kg	100 p.	P
457 010	Laiton	45x79	4,2	25	
457 050	A.Z.	45x79	4	25	

Cotes en mm

9.1 CHARNIÈRES

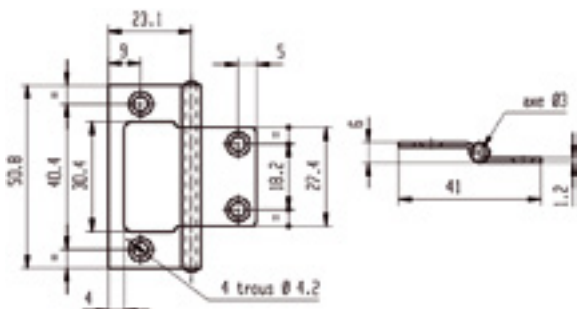
1007 | Charnière universelle à nœud roulé percée fraisée



REF.	FINITION	AxB	Kg 100 p.	
428 110	A.N.	51x40	2	25
428 130	A.L.	51x40	2	25

Cotes en mm

3002 | Charnière abattant A.N. Percée fraisée

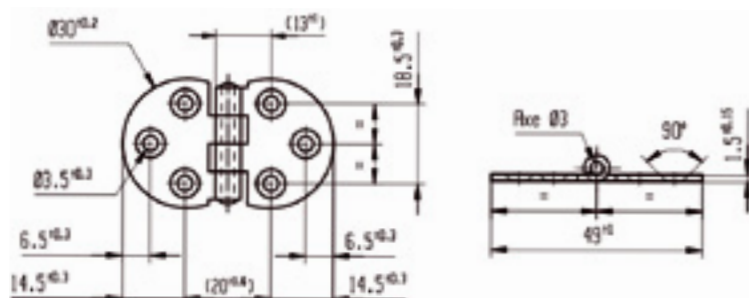





REF.	AxB	Kg 100 p.	
426 330	49x30	3,4	25

Cotes en mm

1015 | Couplet théâtre A.D. percée fraisée - 40 x 90 mm / axe coudé mobile





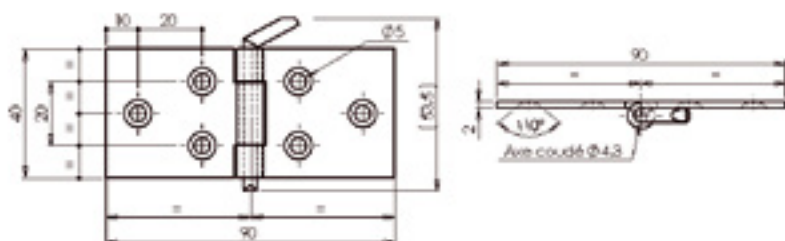

REF.	AxB	 mm	 mm	 Kg 100 p.	
426 350	40x90	4,5	6	7,1	25

Cotes en mm

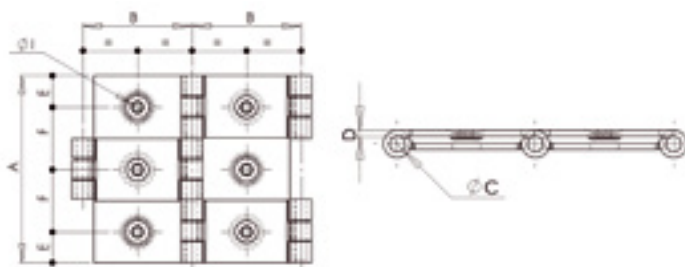
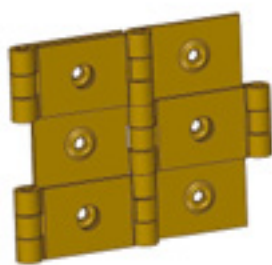

3026 | Charnière de paravent à nœud roulé A.L.







REF.	AxB	C	D	E	F	I	 mm	 mm	 Kg 100 p.	
428 510	40x20	4	1	10	20	3,2	2,5	4	3,2	24
428 550	60x25	3	1,2	10	20	3,6	3	6	5,2	24
428 570	60x30	3	1,2	10	20	3,6	3	6	6	24
428 590	60x35	4	1,5	10	20	3,2	2,5	6	10	24

Cotes en mm

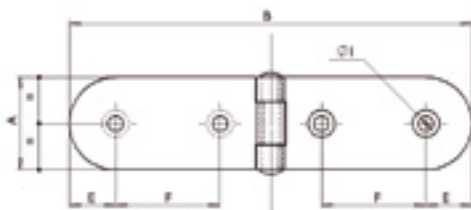
9.2 CHARNIÈRES TYPE CAISSE

7105 | 7106 | Charnière de caisse A.Z. percée fraisée





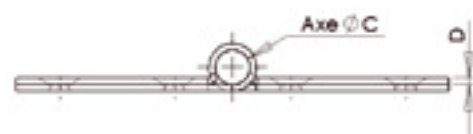
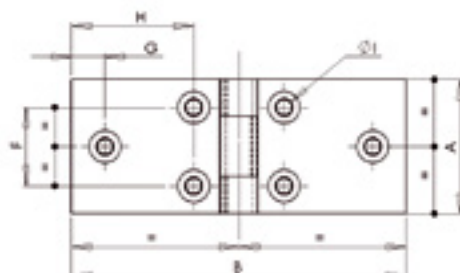

REF.	AxB	C	D	E	F	I	 mm	 mm	 Kg 100 p.	
426 450	30x130	5,9	1,5	15	34	5	4,5	4	5,6	50
426 470	40x190	8	2	20	56	5	4,5	4	18,4	25

Cotes en mm

1016 | Charnière façon canne double feuille A.D. percée fraisée





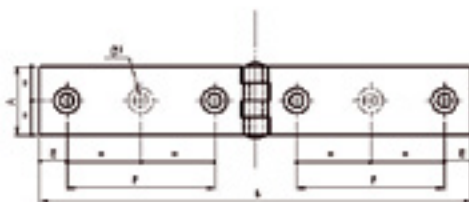

REF.	AxB	C	D	E	F	G	H	I	 mm	 mm	 Kg 100 p.	
426 550	40x100	8	1,5	8,25	23,5	10	36,5	4,7	4	6	11	25

Cotes en mm

1017 | Charnière de coffre à nœud roulé A.Z. percée fraisée





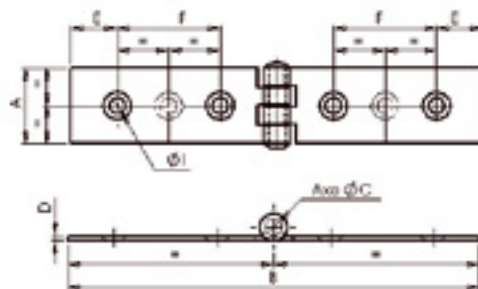
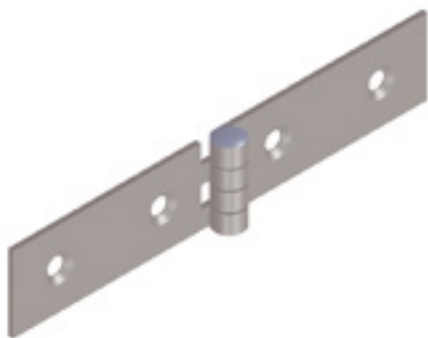

REF.	AxB	C	D	E	F	I	 mm	 mm	 Kg 100 p.	
426 650	30x160	6	2,5	25	32,5	5,3	4,5	4	11	25
426 670	30x200	6	2,5	12	65	5,3	4,5	6	13	25
426 690	35x220	6	2,5	12	76	5,3	4,5	6	17	25

Cotes en mm

1012 | Charnière pour coulisse de lit à nœud roulé A.Z. percée fraisée





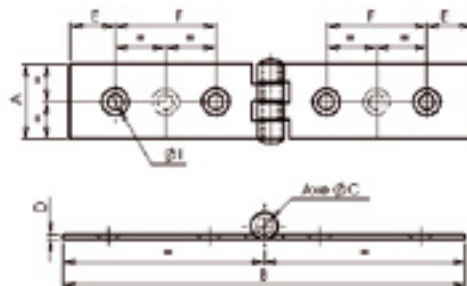
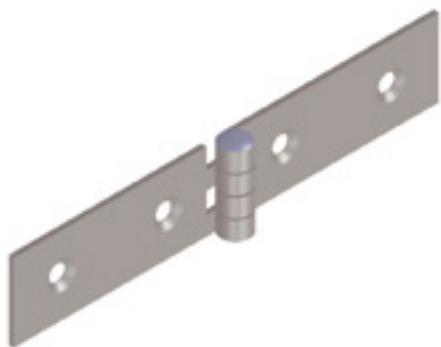

REF.	AxB	C	D	E	F	I	 mm	 mm	 100 p.	
426 710	20x60	3	1,2	6	10	3,2	2,5	4	1,4	25
426 730	20x80	3	1,2	10	16	3,2	2,5	4	1,7	25
426 750	22x100	5	1,5	9	27	4,6	4	4	3	25
426 770	22x120	5	1,5	13,5	30	4,6	4	4	3,7	25

Cotes en mm

1012 | Charnière pour coulisse de lit à nœud roulé A.D. percée fraisée



REF.	AxB	C	D	E	F	I	 mm	 mm	 100 p.	
426 850*	20x60	3	1,2	6	10	3,2	2,5	4	1,4	25
426 870	20x80	3	1,2	10	16	3,2	2,5	4	1,7	25
426 890	22x100	5	1,5	9	27	4,6	4	4	3	25
426 910	22x120	5	1,5	13,5	30	4,6	4	4	3,7	25
426 930	25x140	3,5	1,5	11	46	4,4	4	6	4,6	25
426 950	30x160	3,5	1,5	11	54	4,4	4	6	6	25

Cotes en mm / *VOIR PLAN 1012 LAITON 426 970

9.2 CHARNIÈRES TYPE CAISSE

1013 | Charnière double axe composite

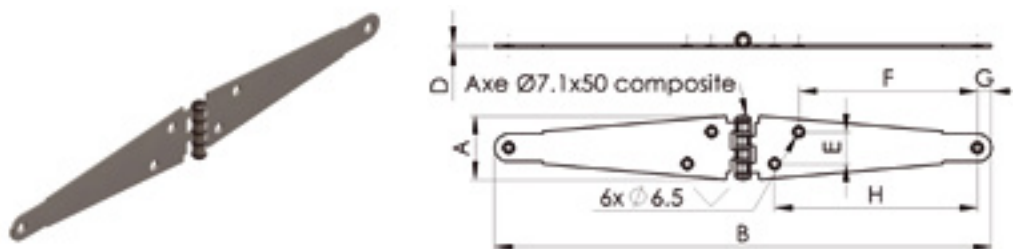

REF.	FINITION	AxB	D	E	F	G	H	Kg 100 p.	
757870	A.Z	50x290	2	25	90	11	110	18,5	10
757970	A.Z NOIR	50x290	2	25	90	11	110	18,5	10
757871	A.Z	50x390	2	25	140	11	159	21,5	10
757971	A.Z NOIR	50x390	2	25	140	11	159	21,5	10

Cotes en mm / Nous consulter pour quantité minimum

1014 | Charnière à congés à nœud roulé A.Z. percée fraisée

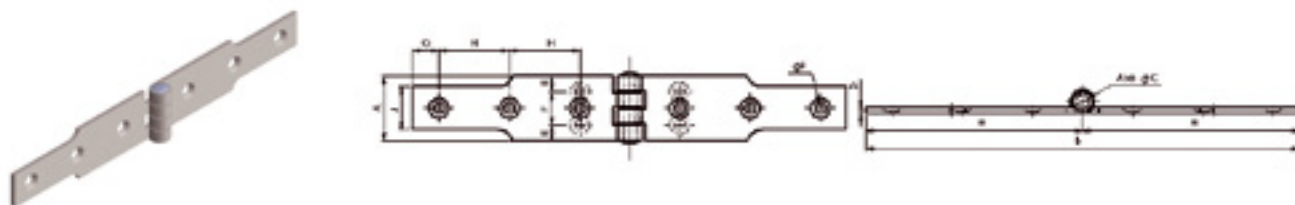

REF.	AxB	C	D	E	F	G	H	I	J			Kg 100 p.	
427 150	25x160	6	2,5			10	25	5,1	17	4,5	6	7,8	25
427 170	30x200	6	2,5			12,5	32,5	5,1	20	4,5	6	11	25
427 180	35x220	6	2,5			12	38	6,2	25	5,5	6	14,3	25
427 190	40x250	6	2,5	9	22	15	45	6,2	30	5,5	8	18	12
427 230	45x275	6	2,5	10	25	15	51	5,6	35	5	8	23,2	12
427 240	50x300	8	3,5	12,5	25	15	51	5,6	34,5	5	8	39	12
427 270	60x300	8	3,5	17,5	25	15	51	5,6	34,5	5	8	46	12

Cotes en mm

1014 | Charnière à congés à nœud roulé A.D. percée fraisée

REF.	AxB	C	D	E	F	G	H	I	J			Kg 100 p.	
427 300	25x160	6	2,5			10	25	5,1	17	4,5	6	7,8	25
427 310	30x200	6	2,5			12,5	32,5	5,1	20	4,5	6	11	25
427 320	35x220	6	2,5			12	38	6,2	25	5,5	6	14,3	25
427 330	40x250	6	2,5	9	22	15	45	6,2	30	5,5	8	18	12
427 340	45x275	6	2,5	10	25	15	51	5,6	35	5	8	23,2	12
427 350	50x300	8	3,5	12,5	25	15	51	5,6	34,5	5	8	39	12

Cotes en mm

1014 | Charnière à congés à nœud roulé INOX axe inox / percée fraisée

REF.	AxB	C	D	E	F	G	H	I	J			Kg 100 p.	
427 520	30x200	6	2,5			12,5	32,5	5,1	20	4,5	6	11	25
427 540	40x250	6	2,5	9	22	15	45	6,2	30	5,5	8	19	12
427 560	50x300	8	3	12,5	25	15	51	5,6	34	5	8	41,5	12

Cotes en mm





9.3 CHARNIÈRES À DÉGONDER

2002 | Charnière à dégonder à nœud roulé A.D. non percée

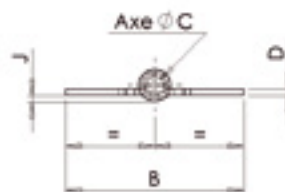
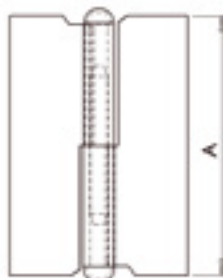

Droite représentée



REF.	DESIGNATION	AxB	C	D	G	H	I	J	 mm	 mm	 Kg 100 p.	
433 170	Droite	70x45	4,5	1,5				1,8			4,8	25
433 180	Gauche	70x45	4,5	1,5				1,8			4,8	25





Cotes en mm

2002 | Charnière à dégonder à nœud roulé A.N. percée fraisée

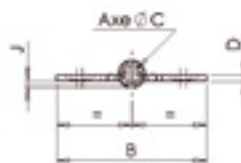
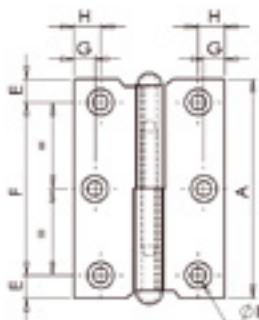

Droite représentée



REF.	DESIGNATION	AxB	C	D	E	F	G	H	I	J	 mm	 mm	 Kg 100 p.	
433 230	Droite	50x30	4	1,2	7,2	34,5	6	6	3,4	1,8	2,5	6	2	25
433 240	Gauche	50x30	4	1,2	7,2	34,5	6	6	3,4	1,8	2,5	6	2	25
433 250	Droite	60x40	4	1,5	6,1	46	5,4	7	4	1,65	3,5	6	3,6	25
433 260	Gauche	60x40	4	1,5	6,1	46	5,4	7	4	1,65	3,5	6	3,6	25
433 270	Droite	70x45	4,5	1,5	7,1	54	6	8	4,5	1,8	4	6	4,8	25
433 280	Gauche	70x45	4,5	1,5	7,1	54	6	8	4,5	1,8	4	6	4,8	25
433 290	Droite	80x50	5	1,5	8,1	62	7	9	4,5	2,1	4	6	6	25
433 300	Gauche	80x50	5	1,5	8,1	62	7	9	4,5	2,1	4	6	6	25

Cotes en mm

9.4 CHARNIÈRES DÉCORATIVES

1700 | Charnière 4 pans nylon Haut. 40 mm - débrochable

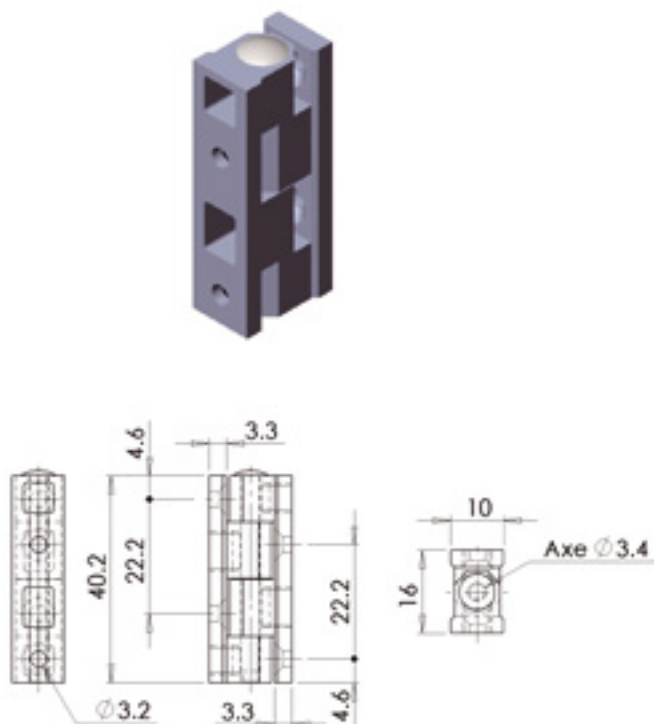

REF.	FINITION	100 p.	P
441030	Blanc axe A.N.	0,87	25
441160	Pin axe A.N.	0,87	25
441180	Chêne axe A.N.	0,87	25
441110	Noir axe A.N.	0,87	25
441410	Blanc axe inox	0,87	25
441450	Noir axe inox	0,87	25

Cotes en mm

Charnière ronde débrochable

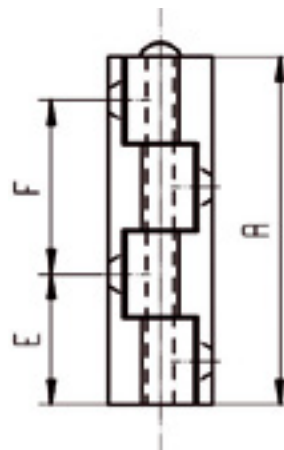
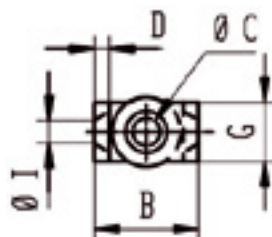



REF.	FINITION	AxB	C	D	E	F	G	I	mm	mm	100 p.	P
443010	Laiton chromé haut. 40mm	40x13,5	4	2	15	20	8,5	3,4	2,5	4	3,05	20
443030	Laiton poli haut. 40mm	40x13,5	4	2	15	20	8,5	3,4	2,5	4	3,05	20
443110	Laiton chromé haut. 50mm	50x15	4	2	18	25	10	3,4	2,5	4	5,1	20

Cotes en mm

9.5 CHARNIÈRES INVISIBLES

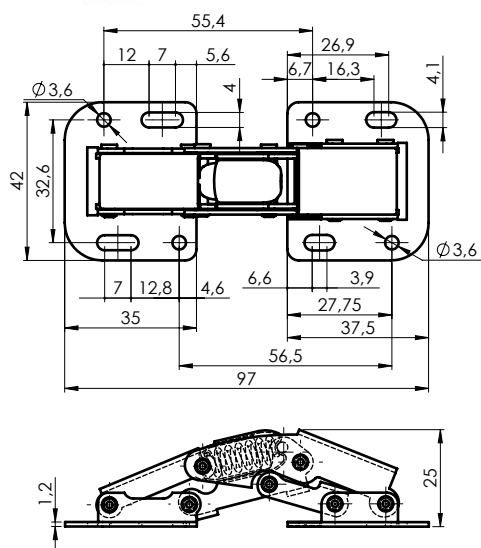
I Charnière à plaquer 90° A.Z. Avec ressort



REF.	 Kg	 100 p.
417 210	7,6	20

Cotes en mm

10.1 CHARNIÈRES PIANO

4003 | Charnière piano à nœud roulé A.N. percée fraisée



REF.	AxB	C	D	E	F	G	I	Kg 100 m	
470 060	960x25	1,8	0,6	7,5	60	15	3,8	16	50
470 260	960x32	1,8	0,6	10	60	15	3,8	19	50

Cotes en mm

4003 | Charnière piano à nœud roulé A.L. percée fraisée



REF.	AxB	C	D	E	F	G	I	Kg 100 m	
470 460	960x25	1,8	0,6	7,5	60	15	3,8	16	50
470 660	960x32	1,8	0,6	10	60	15	3,8	19	50

Cotes en mm

4003 | Charnière piano à nœud roulé inox percée fraisée



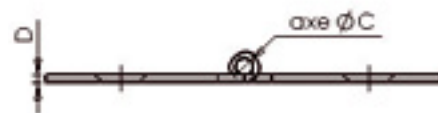
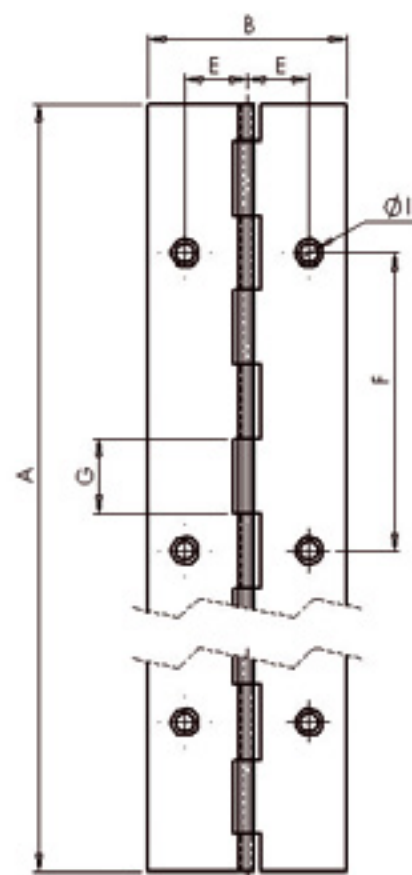

REF.	AxB	C	D	E	F	G	I	Kg 100 m	
470 160	960x25	1,8	0,6	7,5	60	15	3,8	16	50
470 360	960x32	1,8	0,6	10	60	15	3,8	19	50

Cotes en mm

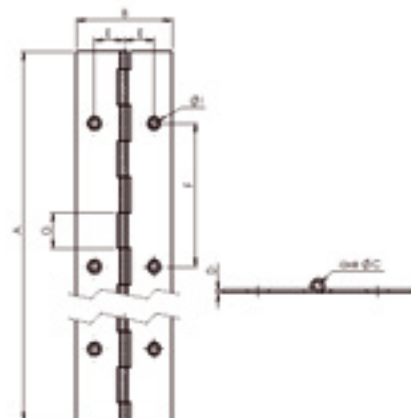

4003 | Charnière piano à nœud roulé A.D. dégraissé percée fraisée



REF.	AxB	C	D	E	F	G	I	Kg 100 m	
471 310	1980x25	1,8	0,6	7,5	60	15	3,8	16	50
471 330	1980x32	1,8	0,6	10	60	15	3,8	19	50
473 240	3480x40	1,8	0,6	12,5	60	15	3,8	23	30

Cotes en mm

4003 | Charnière piano à nœud roulé A.N. nickelé percée fraisée

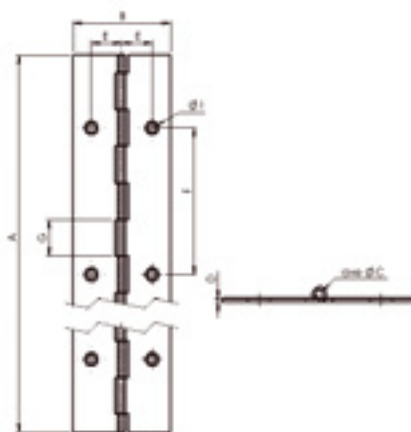

REF.	AxB	C	D	E	F	G	I	Kg 100 m	
471 530	1980x20	1,8	0,6	6,2	60	15	2,8	13	50
471 550	1980x25	1,8	0,6	7,5	60	15	3,8	16	50
471 570	1980x32	1,8	0,6	10	60	15	3,8	19	50
471 590	1980x40	1,8	0,6	12,5	60	15	3,8	23	25
471 610	1980x52	1,8	0,6	15	60	15	3,8	30	25
471 670	3480x25	1,8	0,6	7,5	60	15	3,8	16	30
471 690	3480x32	1,8	0,6	10	60	15	3,8	19	30
471 710	3480x40*	1,8	0,6	12,5	60	15	3,8	23	30

Cotes en mm / *Nous consulter pour quantité minimum

4003 | Charnière piano à nœud roulé A.D. non percée

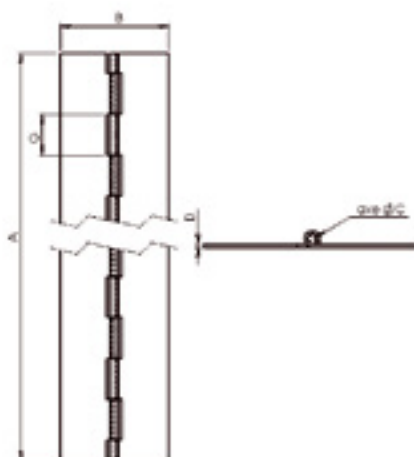



REF.	AxB	C	D	G	Kg 100 m	
473 050	1980x20	1,8	0,6	15	13	50
473 070	1980x25	1,8	0,6	15	16	50
473 090	1980x32	1,8	0,6	15	19	50
473 230	1980x40	1,8	0,6	15	23	25

Cotes en mm

10.1 CHARNIÈRES PIANO

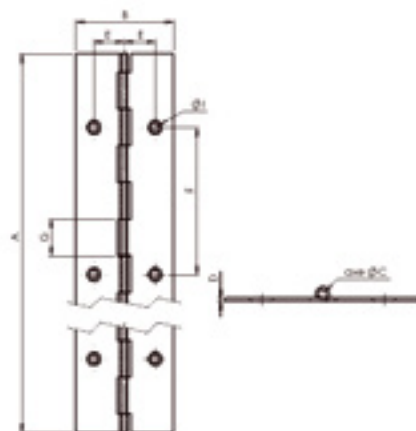
4003 | Charnière piano à nœud roulé A.L. percée fraisée



REF.	AxB	C	D	E	F	G	I	Kg 100 m	
471 770	1980x20	1,8	0,6	6,2	60	15	2,8	13	50
471 790	1980x25	1,8	0,6	7,5	60	15	3,8	16	50
471 810	1980x32	1,8	0,6	10	60	15	3,8	19	50
471 830	1980x40	1,8	0,6	12,5	60	15	3,8	23	25
471 910	3480x25	1,8	0,6	7,5	60	15	3,8	16	30
471 930	3480x32	1,8	0,6	10	60	15	3,8	19	30
471 950	3480x40*	1,8	0,6	12,5	60	15	3,8	23	30

Cotes en mm / *Nous consulter pour quantité minimum

4003 | Charnière piano à nœud roulé LAITON axe FER percée fraisée

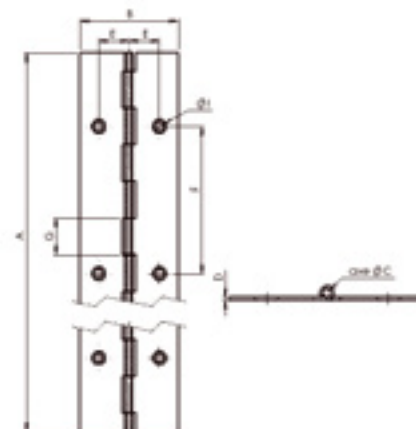



REF.	AxB	C	D	E	F	G	I	Kg 100 m	
472 130	1980x20	1,8	0,6	6,2	60	15	2,8	15	50
472 150	1980x25	1,8	0,6	7,5	60	15	3,8	17,5	50
472 170	1980x32	1,8	0,6	10	60	15	3,8	21	50
472 190	1980x40	1,8	0,6	12,5	60	15	3,8	25	25
472 210	1980x52	1,8	0,6	15	60	15	3,8	33	25
472 250	3480x20*	1,8	0,6	6,2	60	15	2,8	15	30
472 290	3480x32	1,8	0,6	10	60	15	3,8	21	30
472 310	3480x40*	1,8	0,6	12,5	60	15	3,8	25	30

Cotes en mm / *Nous consulter pour quantité minimum

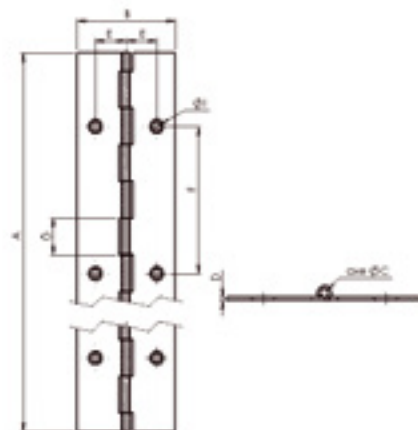
4003 | Charnière piano à nœud roulé LAITON axe LAITON percée fraisée





REF.	AxB	C	D	E	F	G	I	 Kg 100 m		
472 370	1980x20	1,8	0,6	6,2	60	15	2,8	15	50	Sur demande
472 390	1980x25	1,8	0,6	7,5	60	15	3,8	17,5	50	Sur demande
472 410	1980x32	1,8	0,6	10	60	15	3,8	21	50	Sur demande
472 430	1980x40	1,8	0,6	12,5	60	15	3,8	25	25	
472 530	3480x32	1,8	0,6	10	60	15	3,8	21	30	Sur demande
472 550	3480x40*	1,8	0,6	12,5	60	15	3,8	25	30	

Cotes en mm / *Nous consulter pour quantité minimum

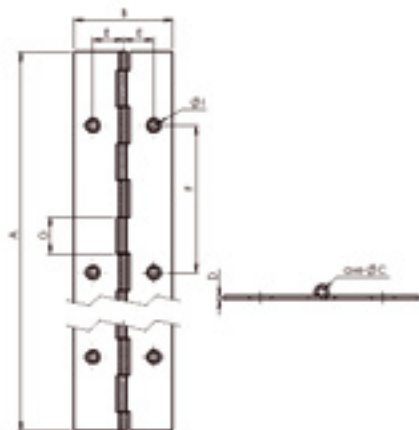
4003 | Charnière piano à nœud roulé INOX percée fraisée





REF.	AxB	C	D	E	F	G	I	 Kg 100 m		
472 610	1980x20	1,8	0,6	6,2	60	15	2,8	13	50	
472 630	1980x25	1,8	0,6	7,5	60	15	3,8	16	50	
472 650	1980x32	1,8	0,6	10	60	15	3,8	19	50	
472 670	1980x40	1,8	0,6	12,5	60	15	3,8	23	25	
472 690	1980x52	1,8	0,6	15	60	15	3,8	30	25	
472 750	3480x25	1,8	0,6	7,5	60	15	3,8	16	30	
472 770	3480x32	1,8	0,6	10	60	15	3,8	19	30	
472 790	3480x40*	1,8	0,6	12,5	60	15	3,8	23	30	

Cotes en mm / *Nous consulter pour quantité minimum

10.2 CHARNIÈRES PIANO FORTES

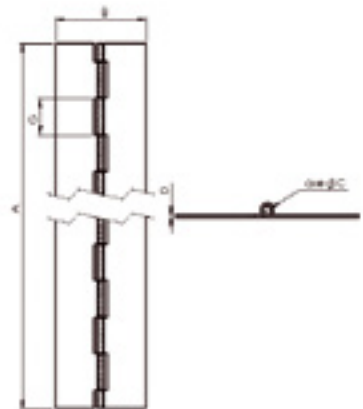
4103 | Charnière piano forte nœud roulé INOX non percée non polie





REF.	AxB	C	D	G	Kg 100 m	
476 080	1980x20	2,5	1	15	21	50
476 090	1980x25	2,5	1	15	28	50
476 100	1980x32	2,5	1	15	34	25
476 210	1980x40	3	1,2	15	52	10
476 220	1980x50	3	1,2	15	62	10

Sur demande
Sur demande

Cotes en mm

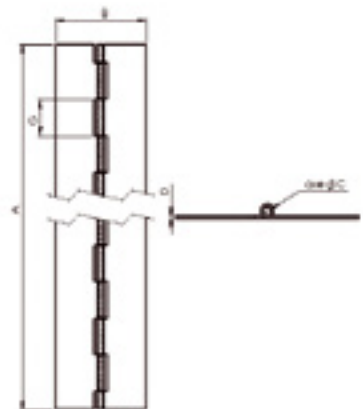
4204 | Charnière piano forte nœud roulé INOX non percée non polie axe Ø 4 mm



REF.	AxB	C	D	G	Kg 100 m	
476 660	1980x40	4	2	30	93	5
476 670	1980x50	4	2	30	109	5
476 690	1980x60	4	2	30	125	5
476 680	1980x70	4	2	30	141	5

Cotes en mm

4206 | Charnière piano forte nœud roulé INOX non percée non polie axe Ø 6 mm

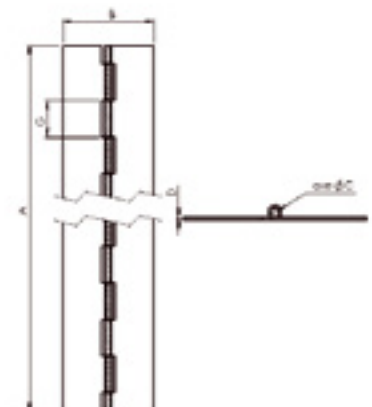

REF.	AxB	C	D	G	Kg 100 m	
476 970	1980x40	6	2	30	111	5
476 980	1980x50	6	2	30	127	5
476 960	1980x60	6	2	30	143	5
476 990	1980x70	6	2	30	159	5

Cotes en mm

4153 | Charnière piano forte nœud roulé INOX
non percée non polie axe Ø 3 mm



REF.	AxB	C	D	G	100 m	P
477 340	1980x30	3	1,5	30	49,98	10
477 350	1980x40	3	1,5	30	62,22	10
477 360	1980x50	3	1,5	30	73,44	10

Sur demande

Cotes en mm

4153 | Charnière piano forte nœud roulé A.D.
non percée axe Ø 3 mm



REF.	AxB	C	D	G	100 m	P
477 270	1980x30	3	1,5	30	49,0	10
477 280	1980x40	3	1,5	30	61,0	10
477 290	1980x50	3	1,5	30	72,0	20

Cotes en mm

4155 | Charnière piano forte nœud roulé INOX
non percée non polie axe Ø 5 mm



REF.	AxB	C	D	G	100 m	P
477 500	1980x40	5	1,5	30	76,5	15
477 510	1980x50	5	1,5	30	88,8	15
477 520	1980x70	5	1,5	30	106,2	10

Sur demande

Sur demande

Sur demande

Cotes en mm

4155 | Charnière piano forte nœud roulé A.D.
non percée axe Ø 5 mm



REF.	AxB	C	D	G	100 m	P
477 420	1980x40	5	1,5	30	75	15
477 430	1980x50	5	1,5	30	87	5
477 450	1980x60	5	1,5	30	98	5
477 440	1980x70	5	1,5	30	104	10

Cotes en mm

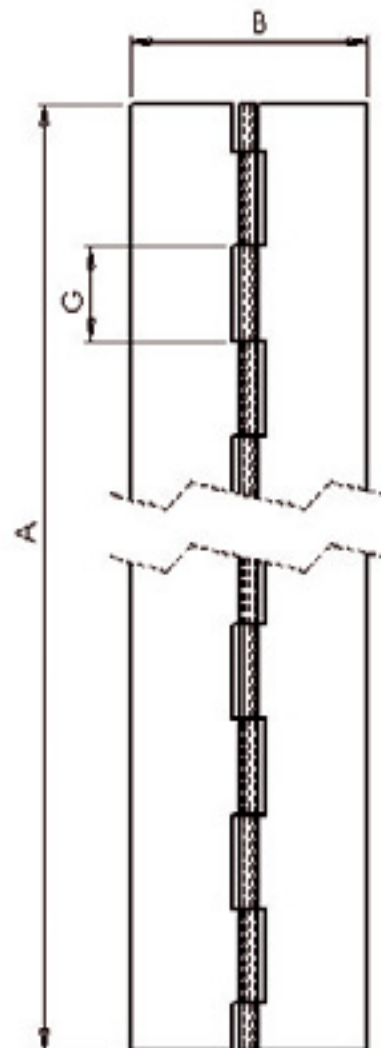

10.3 CHARNIÈRES CAPOT

I 5004 | Charnière capot double feuille A.D. non percée axe Ø 4 mm

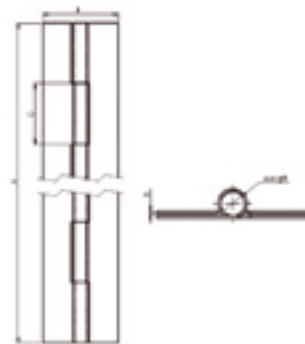

REF.	AxB	C	D	G	Kg 100 m	P
478 550	2000x50	4	0,8 x 2	40	75	5

Cotes en mm

I 5006 | Charnière capot double feuille A.D. non percée axe Ø 6 mm

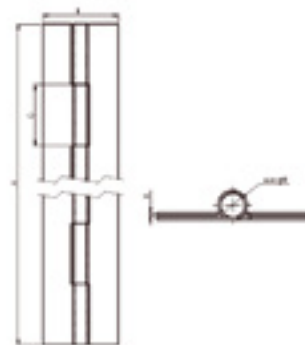

REF.	AxB	C	D	G	Kg 100 m	P
478 870	2000x50	6	0,8 x 2	40	87	5
478 890	2000x60	6	0,8 x 2	40	100	5

Cotes en mm

I 5008 | Charnière capot double feuille A.D. non percée axe Ø 8 mm

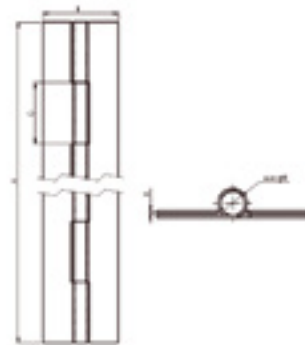

REF.	AxB	C	D	G	Kg 100 m	P
479 270	2000x50	8	0,8 x 2	40	105	5
479 290	2000x60	8	0,8 x 2	40	120	5
479 310	2000x70*	8	0,8 x 2	40	135	5

Cotes en mm / *Nous consulter pour quantité minimum

I 5006 | Charnière capot double feuille A.D. percée fraisée axe Ø 6 mm

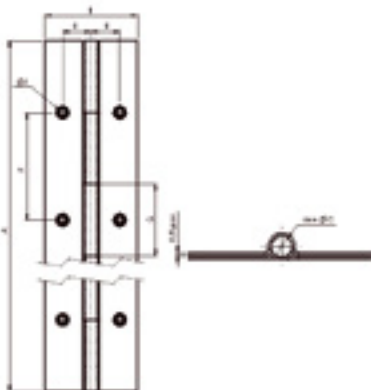
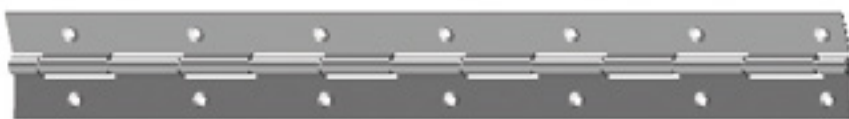

REF.	AxB	C	D	E	F	G	I	mm	Kg 100 m	P
478 970	2000x50	6	0,8 x 2	16	60	40	4	3,5	87	5

Cotes en mm