



Paslode®

FN1650.2

FN1850.2



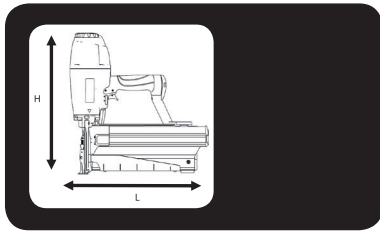

FN1650.2



| | | |
|--|--|--|
| | | A = 270 mm B = 255 mm C = 65 mm |
| | | kg = 1.34 kg |

| |
|---|
| Min. 5,5 bar Max 8,0 bar |
| 0,7 l (6 bar) / |
| Ps max. = 8,0 bar |

| | |
|---|---|
| <small>EN 12549+EN ISO 4871</small> | L_{pA.1s1m} = 80,7 dB(A) L_{pCpeak} < 130 dB(C) |
| <small>ISO 8662-11</small> | Vibration = 1,6 m/s² |

| | |
|---------------|---|
| 85 x = | |
| | D = 2,80 x 1,63 mm d = 1,36 x 1,63 mm L = 15 - 50 mm |



| | |
|---|---|
|  | <p>Sequential trigger actuation/ Einzelauslösung/ enkelschots/ Déclenchement du tir - mode séquentiel/ Funcionamiento secuencial "en continuo"/ Gatilho de actuação sequencial/ funzionamento sequenziale (colpo a colpo) Enkeltskuds aftrækker/ Enkelskott/ Enkeltskudds avtrekker/ Kertalaukaisu/ Úksiklasu meetodil töötamine/ Uruchomienie spustu sekwencyjne/ Sekvenčni spoušť/ Egyes lövés (szakaszosan működtetett elsütő billentyűvel)/ Posamezno proženje/ Kontaktirajte singl / Последовательная активация при нажатии на курок/ Sekvenčná aktivácia spúšte/ التشغيل بالزر التسلسلي المقيد / Nuoseklusis paleidimo mechanizmas/ Sekvencialās palaišanas iedarbināšana Raðkveikjuvirkjun</p> |
|  | <p>Contact trigger actuation/ Kontaktauslösung/ repeterend schieten/ Déclenchement du tir - mode rafale/ Funcionamiento por contacto "clavo a clavo"/ Gatilho de actuação por contacto/ funzionamento a contatto/ Stødskydnings aftrækker/ Støtskjutning/ Støtspirkings avtrekker/ Kosketuslaukaisu/ Automaatmeetodil töötamine/ Uruchomienie spustu przez kontakt/ Kontaktní spoušť/ Sorozatlövés (folyamatosan behűzött elsütő billentyűvel)/ Kontaktno proženje/ Kontaktirajte pokretanje/ Контактная активация при нажатии на курок/ Kontaktná aktivácia spúšte/ التشغيل بتلامس الزر / Kontaktinis paleidimo mechanizmas/ Kontakta palaišanas iedarbināšana/ Snertikveikjuvirkjun</p> |

Model: FN1650.2 Sequential
No. 576910



| | | | | | |
|-------------------|------------------|------------------|-------------------|--|-----------|
| | | | | | |
| <p>No. 576941</p> | <p>No.576928</p> | <p>No.576935</p> | <p>No. 014121</p> | | <p>2x</p> |

Accessories

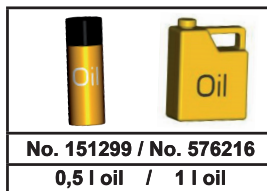

No. 151299 / No. 576216

0,5 l oil / 1 l oil

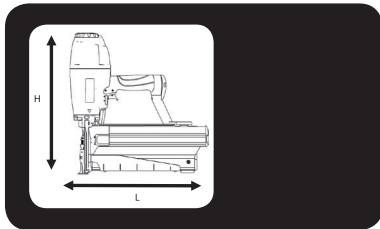

FN1850.2



| | | |
|--|--|--|
| | | A = 270 mm B = 255 mm C = 65 mm |
| | | = 1.34 kg |

| |
|---|
| Min. 5,5 bar Max 8,0 bar |
| 0,7 l (6 bar) / |
| Ps max. = 8,0 bar |

| | |
|---|---|
| <small>EN 12549+EN ISO 4871</small> | L_{pA.1s1m} = 85,3 dB(A) L_{pCpeak} < 130 dB(C) |
| <small>ISO 8662-11</small> | Vibration = 1,7 m/s² |







| | |
|----------------|---|
| 115 x = | |
| | D = 1,90 x 1,25 mm d = 1,00 x 1,25 mm L = 16 - 50 mm |



| | |
|---|--|
|  | <p>Sequential trigger actuation/ Einzelauslösung/ enkelschots/ Déclenchement du tir - mode séquentiel/ Funcionamiento secuencial "en continuo"/ Gatilho de actuação sequencial/ funzionamento sequenziale (colpo a colpo) Enkeltskuds aftrækker/ Enkeltskott/ Enkeltskudds avtrekker/ Kertalaukaisu/ Üksiklasu meetodil töötamine/ Uruchomienie spustu sekwencyjne/ Sekvenčni spoušť/ Egyes lövés (szakaszosan működtetett elsütő billentyűvel)/ Posamezno proženje/ Kontaktirajte singl / Последовательная активация при нажатии на курок/ Sekvenčná aktivácia spúšte/ التشغيل بالزر التسلسلي المقيد / Nuoseklusis paleidimo mechanizmas/ Sekvencialās palaišanas iedarbināšana Raðkveikjувirkjun</p> |
|  | <p>Contact trigger actuation/ Kontaktauslösung/ repeterend schieten/ Déclenchement du tir - mode rafale/ Funcionamiento por contacto "clavo a clavo"/ Gatilho de actuação por contacto/ funcionamento a contacto/ Stødskydnings aftrækker/ Støtskjutning/ Støtspikrings avtrekker/ Kosketuslaukaisu/ Automaatmeetodil töötamine/ Uruchomienie spustu przez kontakt/ Kontaktní spoušť/ Sorozatlövés (folyamatosan behűzött elsütő billentyűvel)/ Kontaktno proženje/ Kontaktirajte pokretanje/ Контактная активация при нажатии на курок/ Kontaktná aktivácia spúšte/ التشغيل بتلامس الزر / Kontaktnis paleidimo mechanizmas/ Kontakta palaišanas iedarbināšana/ Snertikveikjувirkjun</p> |

Model: FN1850.2 Sequential
No. 576909



| | | | | | |
|---|---|---|---|---|--|
|  |  |  |  |  |  2x |
| No. 576941 | No.576928 | No.576935 | No. 014121 | | |

Accessories

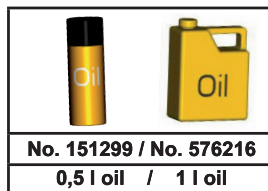

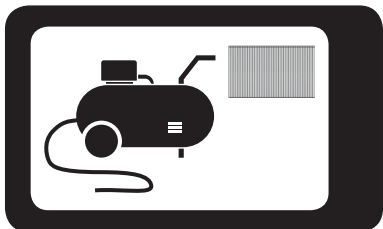

014 748

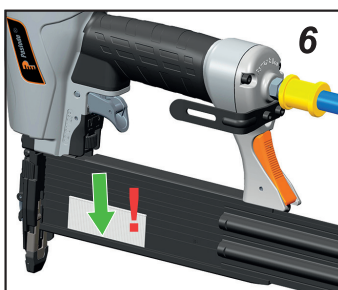
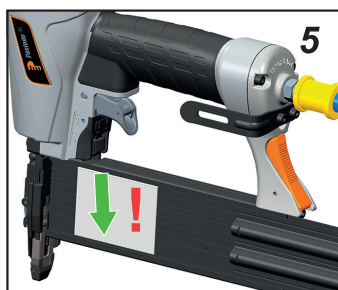
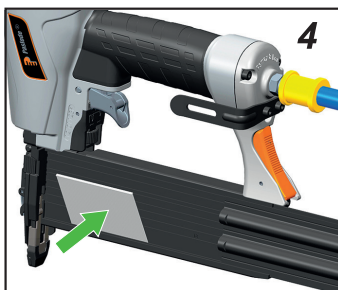
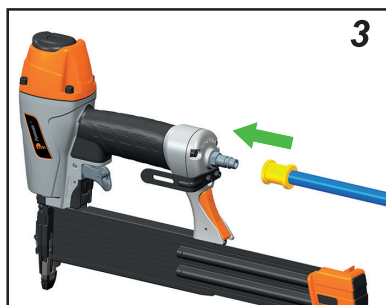
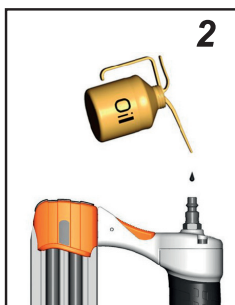
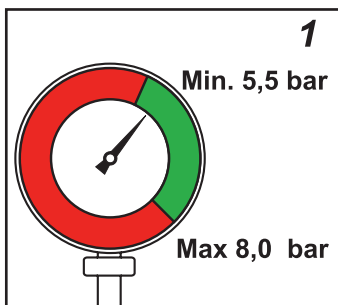

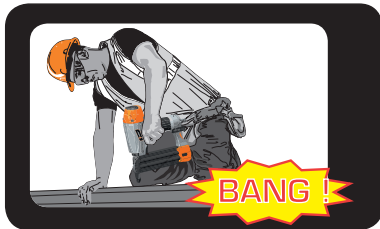

014 748

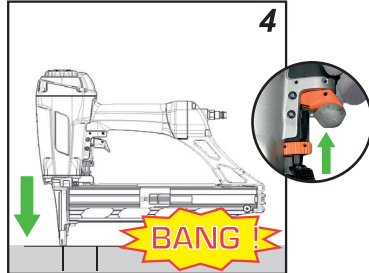
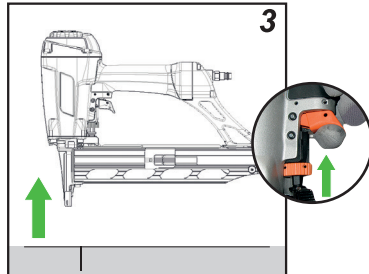
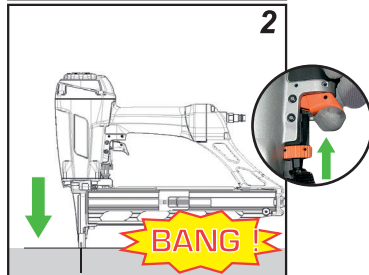
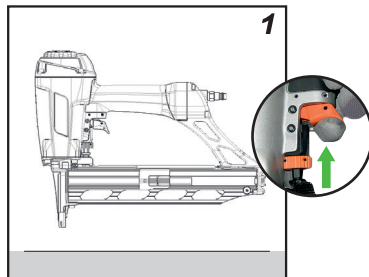
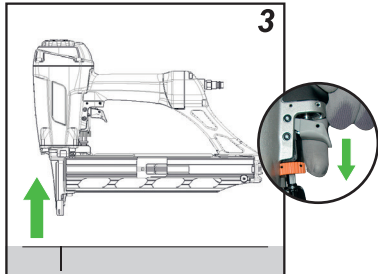
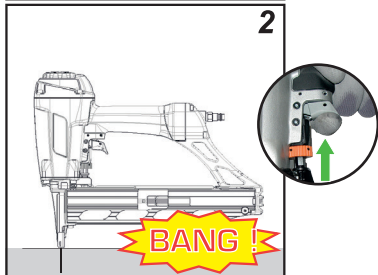
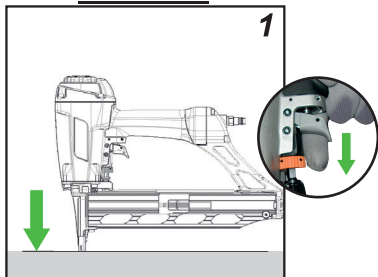

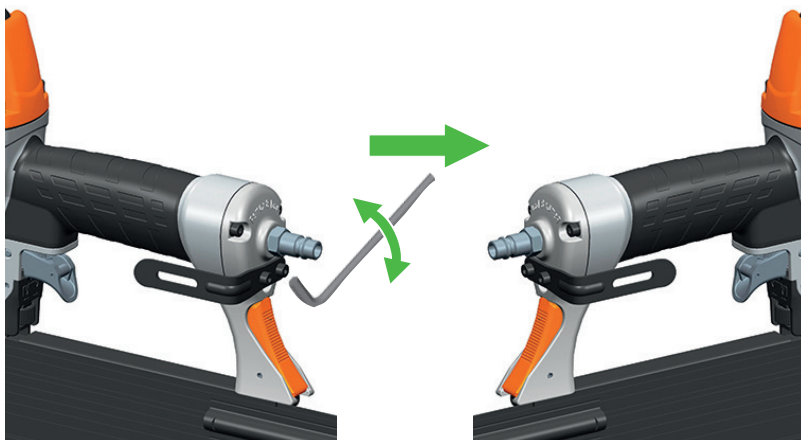
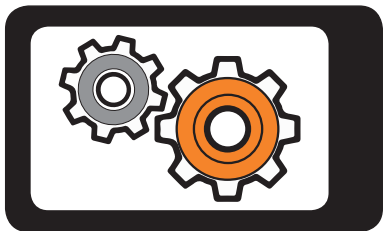

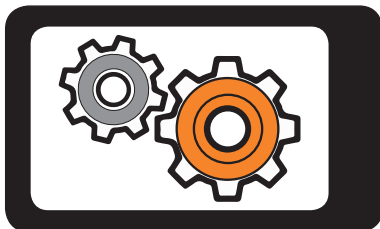

No.576928



No.576935

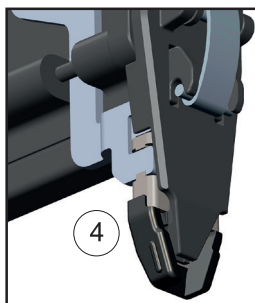
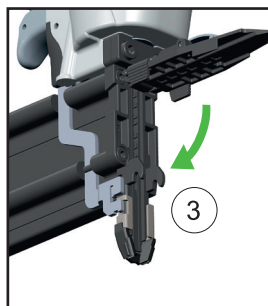
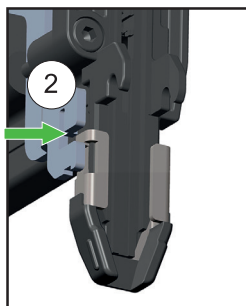
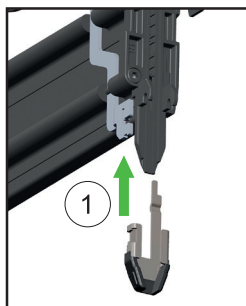
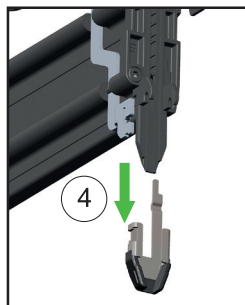
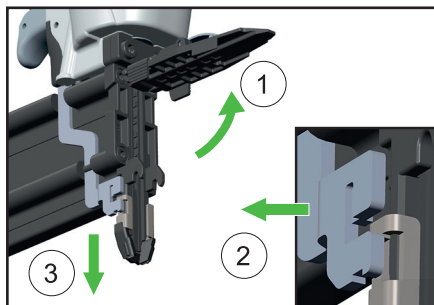

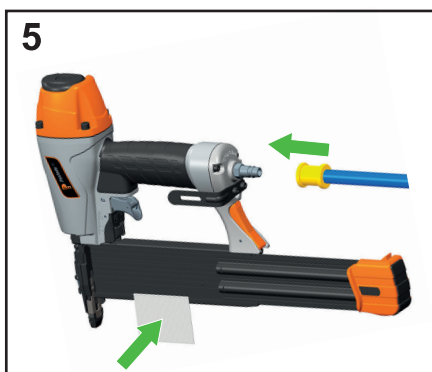
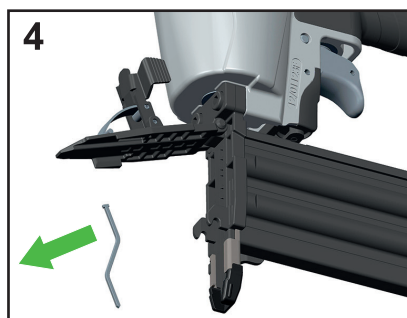
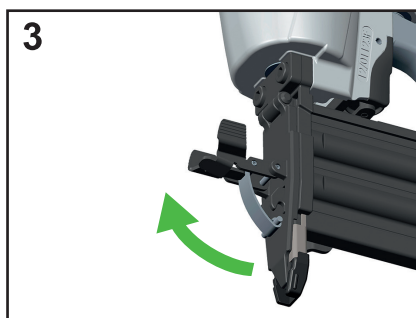
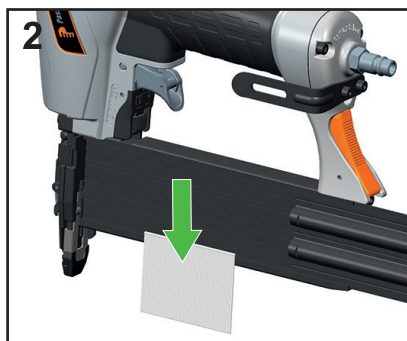
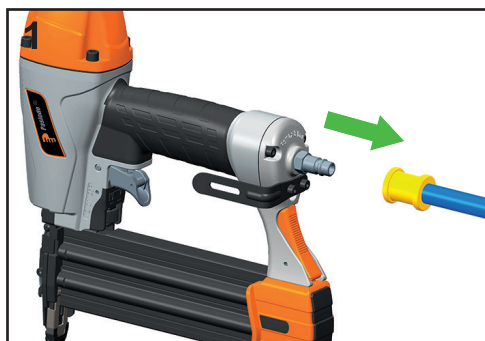
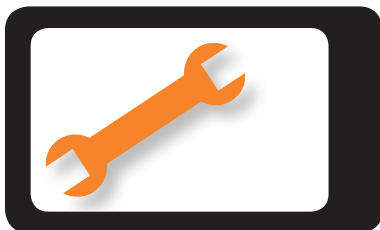

YY/WW....



YY= Year of manufacture
WW = Week of manufacture

**Resting position/ Ruheposition/ Position de repos/ Ruststand/
Posición de descanso/ Posizione di riposo/ Posição de des-
canso/ Pozycja spoczynku/ Klidová poloha/ Nyugalmi állapot/
Положение в нерабочем состоянии/ Θέση αδράνειας/ Hvile-
stilling/ Viloläge/ Hvileposisjon/ Lepoasento/ Položaj mirovanja/
Pokojová poloha/ Položaj mirovanja/ وضع السكون / Ramybės
padėtis/ Ooteasend/ Miera stāvoklis/ Hvíldarstaða**





ITW CONSTRUCTION PRODUCTS EUROPE
Code 576941 (02/2017)
www.paslode.eu