



MANTION

WWW.MANTION-MANUTENTION.COM

MANUTENTION AÉRIENNE

HANDLING SYSTEM

MANUTENCIÓN AÉREA



SPORTUB
712





MANTION ET SON LABORATOIRE D'ESSAI:

Mantion soucieux de la qualité de ses produits, dispose de l'un des plus grands centres d'essais d'Europe dans le domaine du coulisant. En effet ce n'est pas moins de 5 bancs d'essai qui martyrisent à longueur d'année des systèmes coulisants, afin d'éprouver leur endurance. Tous les systèmes Mantion sont soumis à ces essais préalables, le tout réalisé avec la rigueur de la norme ISO 9001.

MANTION AND ITS TEST LABORATORY:

Mantion, which always focuses on the quality of its products, has one of the biggest test laboratories for sliding systems in Europe. 5 test stands enable Mantion to assay the endurance of all its sliding systems in order to comply with the requirements of the ISO 9001 standard.

MANTION Y SU LABORATORIO DE PRUEBAS:

Mantion, preocupado por dar la máxima calidad a sus productos, dispone de uno de los más grandes centros de pruebas en Europa en el ámbito del transporte aéreo. De hecho, no son menos de 5 bancos de pruebas que martirizan a todo lo largo del año los sistemas correderos, con el fin de probar su resistencia. Todos los sistemas Mantion están sometidos a estas pruebas previas, siempre realizadas bajo el riguroso control de la normativa ISO 9001.

Nos éléments standards permettent de réaliser aisément des installations personnalisées. La durée de vie des composants installés est variable selon ses conditions d'utilisation et de l'environnement dans lequel il se trouve. Dans tous les cas, elles doivent être déterminées par l'installateur. Celui-ci tiendra compte du fonctionnement, de l'espacement des supports, de la nature et du volume des charges transportées.

Nos articles sont garantis contre tout vice de fabrication, toutefois, cette garantie est limitée au remplacement des pièces défectueuses, à l'exclusion de tous dommages et intérêts, pour quelque cause que ce soit. Les pièces ayant subi une modification ou installées selon d'autres procédures (disponibles sur demande) que celles que nous recommandons ne bénéficieront pas de la garantie.

Our standard elements make possible to create easily personalized installations. The lifespan of the components installed is variable according to its environment and conditions of use. In all cases, they must be determined by the resaler. This one will take care of the running method, the spacing of the brackets, the nature and the volume of the transported loads.

Our products are warranted against manufacture fault, however, this warranty is limited to the replacement of the defective parts only and not for damages or consequential claims of any nature. Modified parts and material installed in a different way than the one we are recommended (recommendations available on demand) are not under warranty any more.

Nuestros elementos estándares permiten realizar fácilmente instalaciones personalizadas. La duración de vida de los componentes instalados es variable en función de las condiciones de uso y del entorno en el que están situados.

En todo caso, deben de estar determinados por el montador. Este tomará en cuenta el funcionamiento, el espacio entre los soportes, la naturaleza y el volumen de las cargas transportadas.

Nuestros artículos están garantizados contra cualquier vicio de fabricación, sin embargo, esta garantía está limitada al reemplazo de los recambios defectuosos, con exclusión de cualquier daño y perjuicio, por el motivo que sea. Los recambios que hayan sufrido una modificación o instalados según otros procedimientos que aquellos que recomendamos nosotros (disponibles sobre petición) no se beneficiarán de la garantía.

Nos produits ne sont pas soumis à l'autocertification CE car ils sont vendus en tant que composants indépendants. Cela devient une machine lorsque ils sont montés sous une charpente par le constructeur. La certification CE doit alors être produite par le concepteur de l'installation.

Our product are not suitable for autocertification CE because they are sold as independant parts. They are becoming a machine when they are built up together linked with a steel construction. The CE certification have to be done by the installator.

Nuestros productos no están sometidos a auto certificación CE porque están vendidos en tanto como componentes independientes. Se convierten en una máquina cuando están montados debajo de una estructura por el constructor. La certificación CE por lo tanto tiene que estar presentada por el diseñador de la instalación.



RAILS ET COURBES
TRACKS AND CURVES / RAILES Y CURVAS



Rails / Tracks / Riales 04
 - Courbes / Curves / Curvas..... 05

AIGUILLAGES
SWITCHES / CAMBIOS DE VÍAS

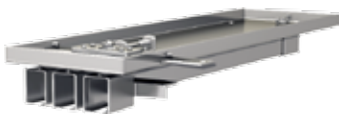

- Aiguillages / switches / Cambios de vías 05

FIXATIONS
HANGER / FIJACIÓN

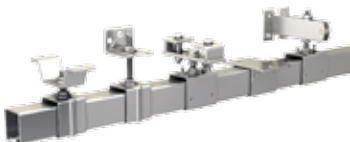

- Supports / Brakets / Muffe Soportes de fijación 06
 - Manchons / Jointings Brackets / Manguitos 06
 - Pattes de fixation / Fixing plates / Patas de fijación 07

CHARIOTS
TROLLEYS / CARROS



- Chariots à 2 galets / Trolley with 2 rollers / Carro de 2 ruedas..... 09
 - Chariots à 4 galets / Trolley with 4 rollers / Carro de 4 ruedas..... 09
 - Chariots double / Double trolley / Carro doble 10
 - Butées / Stoppers / Topes 11
 - Enjoliveurs pour extrémité de rail / End rail cap / Tapón final de raíl 11
 - Corchets et anneaux / Hooks and rings / Ganchos y argollas 11

PORTE CÂBLE
TROLLEYS / CARROS PORTA CABLES



- Porte câble / Cable carriers / Carros porta cables 12
 - Accessoires / Accessories / Accesorios 14





Les rails de notre fabrication portent le logo , c'est une garantie de qualité. IMPORTANT: les rails doivent être fixés de niveau grâce à nos supports spéciaux

The tracks manufactured by MANTION have their own logo . It is a guarantee of quality. IMPORTANT: Use our special brackets as the tubular profile must be level.

Los rails de nuestra fabricación llevan nuestro logo , es una garantía de calidad. IMPORTANTE: los railes tienen que estar sujetos de nivel por medio de nuestros soportes.

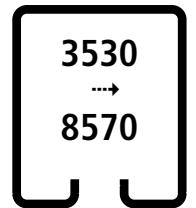
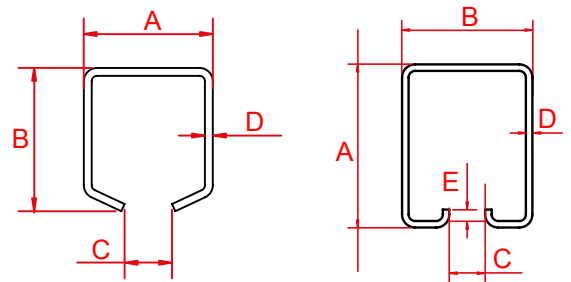
Ref	A	B	C	D	E	Lg rail	
2525	2525F/400	25	26	10	1.5	-	4000
	2525F/500	25	26	10	1.5	-	5000
	2525F/600	25	26	10	1.5	-	6000
3530	3530/400	35	30	7	1.5	5	4000
	3530/500	35	30	7	1.5	5	5000
	3530/600	35	30	7	1.5	5	6000
5040	5040/400	50	40	11	2	5.5	4000
	5040/500	50	40	11	2	5.5	5000
	5040/600	50	40	11	2	5.5	6000
6255	6255/400	62	55	19	2.5	8	4000
	6255/500	62	55	19	2.5	8	5000
	6255/600	62	55	19	2.5	8	6000
8570	8570/400	85	70	20	3.5	15	4000
	8570/500	85	70	20	3.5	15	5000
	8570/600	85	70	20	3.5	15	6000



■ Cotes en mm -  Dim in mm -  Cotas en mm

■ **CHARGE UNITAIRE ENTRE DEUX POINTS** /  Load in the middle of 2 points /  Carga unitaria entre 2 puntos

L (m.)

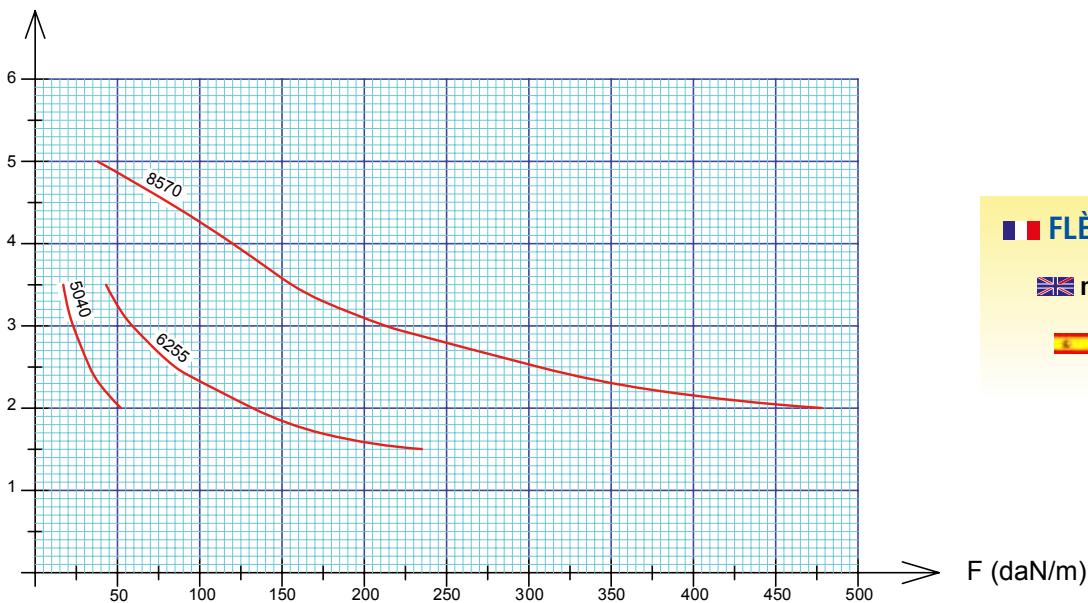

■ **FLÈCHE MAXI = 1/500^{EME}**

 max deflection = 1/500

 Flecha máx = 1/500

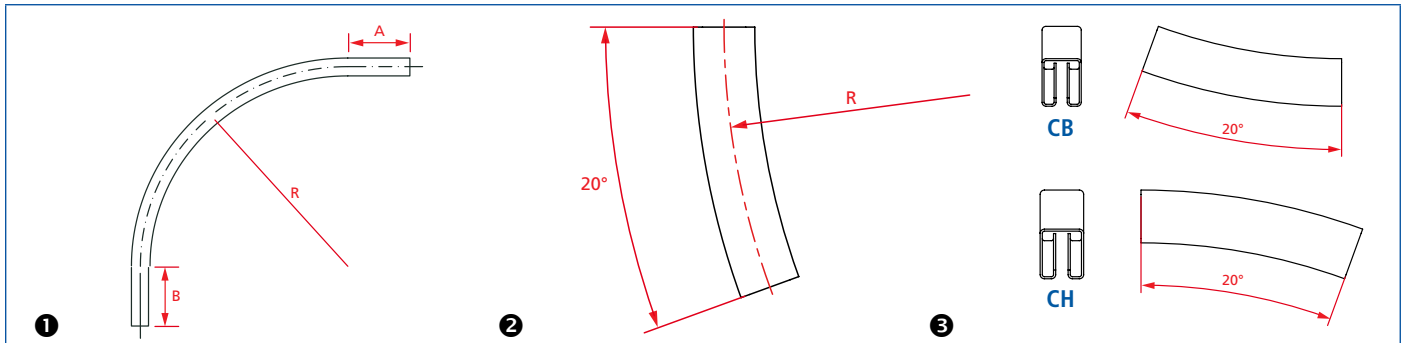

	A	B	R
1 ■ ■ Courbes horizontales à 90° / ■ Horizontal curves at 90° / ■ Curvas horizontales 90°			
2525C	492.5	372.5	400
3530C	350	350	500
5040C	360	300	600
6255C	250	300	800
8570C	120	200	1000
2 ■ ■ Secteurs horizontaux 20° / ■ Horizontal sectors at 20° / ■ Sectores horizontales 20°			
	2525CS		400
	3530CS		500
	5040CS		600
	6255CS		800
	8570CS		1000
3 ■ ■ Secteurs verticaux 20° / ■ Vertical sectors at 20° / ■ Sectores verticales 20°			
	2525CB	2525CH	400
	3530CB	3530CH	500
	5040CB	5040CH	600
	6255CB	6255CH	800
	8570CB	8570CH	1000

> ■ ■ AIGUILLAGES / ■ Switches / ■ Cambios de vías

	Ref	A	B	C	D	E	F	G	H	I
2525	8250	650	180	77.5	140	97	14.5	10.5	463	35
3530	8350	650	180	85	140	97	14.5	10.5	463	35
5040	8500	749	220	107	180	90	14.5	10.5	284.5	35
6255	8620	1060	310	125	258	120	15	10.5	410	35
8570	8850	1276	360	165	308	128	15	10.5	510	40

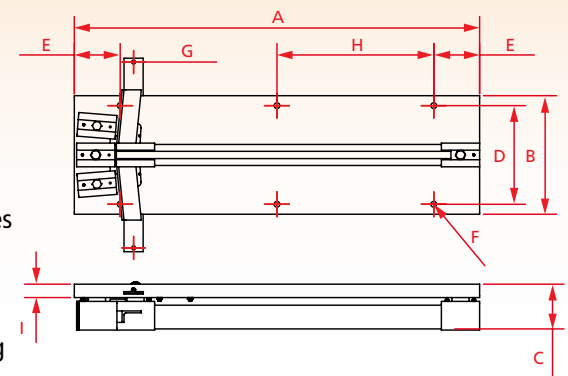
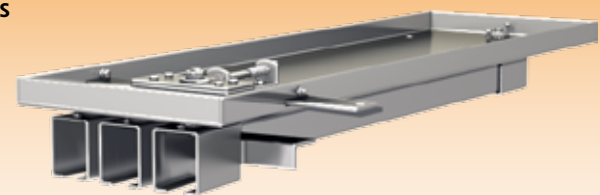

■ ■ La manoeuvre de ces aiguillages est assurée par une tirette va-et-vient à 3 positions de verrouillage. Celle-ci est percée de 2 trous permettant le montage de poignées ou l'accrochage de câbles ou de chaînes (ces éléments de manoeuvre ne sont pas fournis). La commande peut être manuelle, pneumatique ou autre ...

■ The operation of these switches is performed by a pull back and forth to 3 locking positions. It is pierced with two holes for the mounting of the attachment of handles or wires or chains (These control elements are not provided). The control can be manual, pneumatic or other ...

■ La maniobra de estos cambios de vías se hace por medio de una cadenita de 3 posiciones de bloqueo. Esta taladrado con 2 agujeros para el montaje de tiradores o el enganche de cables o de cadenitas. (Estos elementos de maniobra no están suministrados) El mando puede ser manual, neumático u otro...

SUPPORT ENVELOPPANT TIGE NORMALE

🇬🇧 Hanger with normal threaded rod
🇪🇸 Soporte envolvente varilla normal

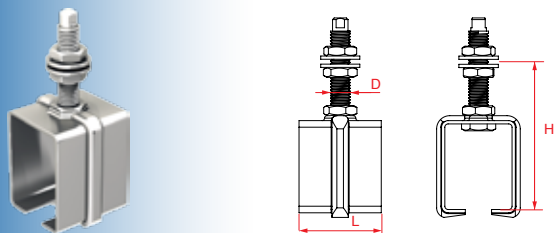

□	Ref	D	L	H
2525	2521	M8	28	45 ±1
3530	3531	M10	30	67 ±7
5040	5041	M12	50	88 ±12
6255	6256	M14	64	100 ±5
8570	8571	M20	86	132 ±4
8570	8578MC*	M20	110	134 ±2

SUPPORT ENVELOPPANT TIGE LONGUE

🇬🇧 Hanger with long threaded rod
🇪🇸 Soporte envolvente varilla larga

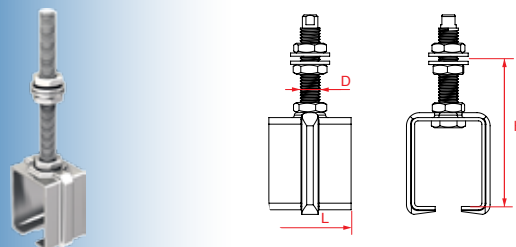

□	Ref	D	L	H
2525	2521L	M8	28	62 ±15
3530	3531L	M10	30	60 ±30
5040	5041L	M12	50	110 ±30
6255	6256L	M14	64	125 ±30
8570	8571L	M20	86	165 ±35
8570	8578ML*	M20	110	134 ±30

SUPPORT ENVELOPPANT FIXATION MURALE

🇬🇧 Wall fixing hanger
🇪🇸 Soporte envolvente fijación a la pared

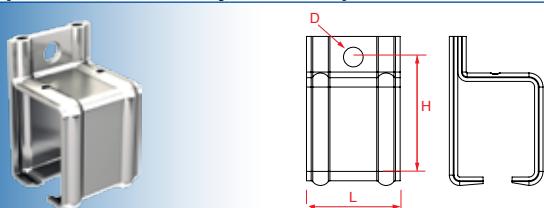

□	Ref	D	L	H
3530	3631	8.2	40	49
5040	5141	10.5	50	64
6255	6356	12.5	65	83

SUPPORT ENVELOPPANT FIXATION PLAFOND

🇬🇧 Roof fixing hanger
🇪🇸 Soporte envolvente fijación al techo

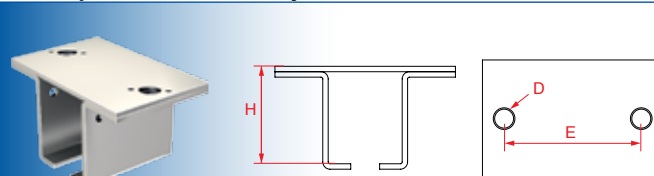

□	Ref	D	E	H
3530	3634	6.5	58	38.5
5040	5144	10.5	76	54
6255	6359	12.5	96	66

MANCHON DE RACCORDEMENT NU

🇬🇧 Jointing
🇪🇸 Manguito solo unión

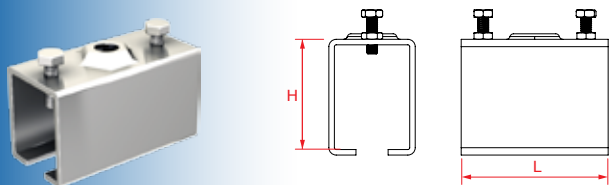

□	Ref	A	C
2525	2521M	36	45
3530	3531M	44	75
5040	5041M	63	80
6255	6256M	75	100
8570	8578M*	106	110

MANCHON SUPPORT TIGE COURTE

🇬🇧 Jointing with normal threaded rod
🇪🇸 Manguito soporte varilla corta

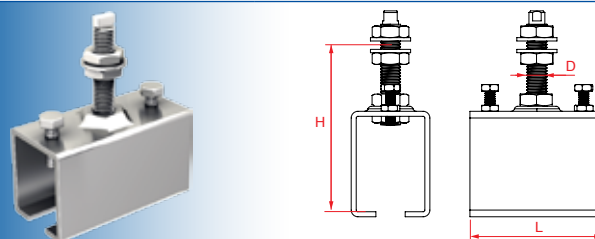

□	Ref	D	L	H
2525	2521MC	M8	45	45 ±1
3530	3531MC	M10	75	67 ±7
5040	5041MC	M12	80	88 ±12
6255	6256MC	M14	100	100 ±5
8570	8578MC*	M20	110	132 ±4

■ * Utiliser les réf. 8578 toutes versions avec les pattes type S pour charges supérieures à 160 Kg.
🇬🇧 * Use the réf. 8578 with all versions of S type hangers for loads higher than 160 kg.
🇪🇸 * Utilizar todas las versiones de ref. 8578 con soportes de tipo S para cargas superiores a 160 Kg.

MANCHON SUPPORT TIGE LONGUE

Jointing with long threaded rod
Manguito soporte varilla larga

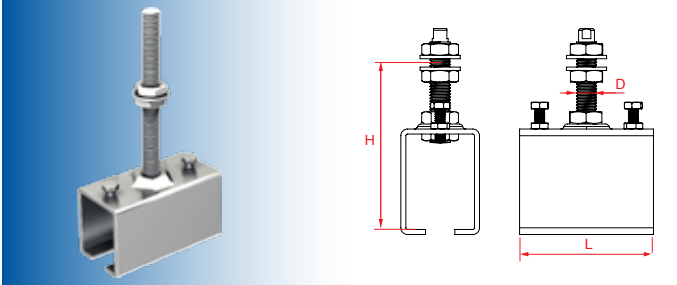

□	Ref	D	L	H
2525	2521ML	M8	45	62 ±15
3530	3531ML	M10	75	60 ±30
5040	5041ML	M12	80	110 ±30
6255	6256ML	M14	100	125 ±30
8570	8571ML*	M20	110	165 ±35

MANCHON SUPPORT FIXATION PLAFOND

Roof fixing jointing
Manguito soporte fijación al techo

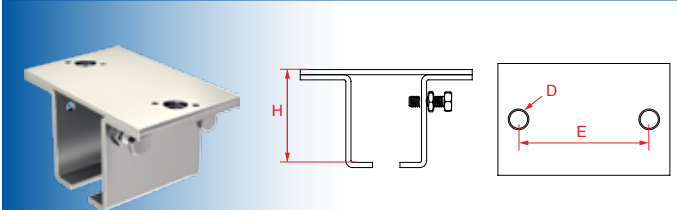

□	Ref	D	E	H
3530	3634M	6.5	58	38.5
5040	5144M	10.5	76	54
6255	6359M	12.5	96	66

PATTE À VISSER AU PLAFOND

Roof fixing plate
Soporte al techo para atornillar

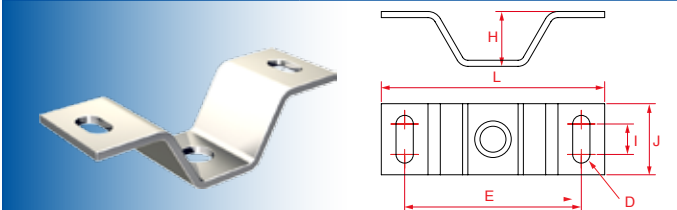

□	Ref	H	L	E	D	I	J
2525	2524	16.6	92	70	6.3	6	25
3530	3534	20	92	70	6.3	6	25
5040	5044	27	110	87	8.5	15	35
6255	6259	42	154	130	10.5	0	50
8570	8574	40	155	133	12	0	70

MANCHON SUPPORT FIXATION MURALE

Wall fixing jointing
Manguito soporte fijación a la pared

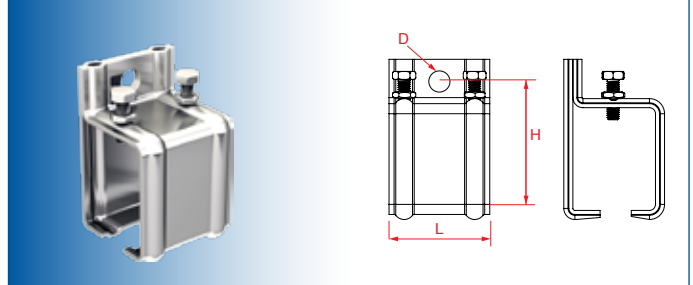

□	Ref	D	L	H
3530	3631M	8.2	40	49
5040	5141M	10.5	50	64
6255	6356M	12.5	65	83

PATTE ÉQUERRE À VISSER

L corner to be screwed
Soporte escuadra para atornillar

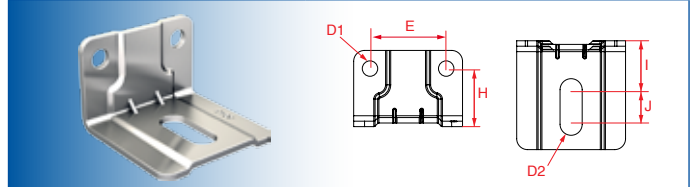

□	Ref	D1	E	H	D2	I	J
2525	2523	4.2	21	15	8.2	14	11
3530	3533	6.5	30	17.5	10.2	18	12
5040	5043	8.5	42	32	12.2	27	19
6255	6258	11.2	49.5	26	14	38	20
8570	8573	11	72	43	21	42	20
8570	8573S**	12.5	70	35	21	42	20

PATTE DE RÉGLAGE À VISSER

Adjustment plate to be screwed
Soporte ajustable para atornillar

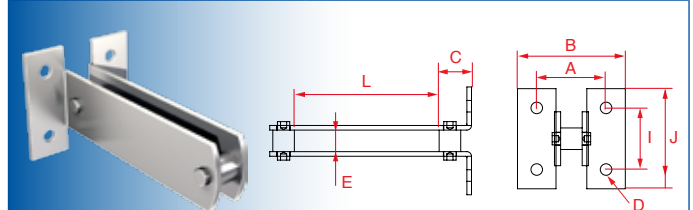

□	Ref	L	C	E	A	B	D	I	J
3530	3536	74	21	11	30	49	6.5	35	50
5040	5046	94	21	14	45	70	7.5	40	65
6255	6261	125	24.8	16	59	94	8.5	50	80
8570	8576	159	30	22	72	112	10.5	65	90
8570	8576S**	158	31	22	74	114	10.5	65	110

** Patte renforcée à utiliser avec toutes les versions de supports et manchons réf. 8578.

** Enhanced for use with all hangers versions and couplings ref. 8578.

** Soporte reforzado para utilizar con todas las versiones de soportes y manguitos ref. 8578.

■ ■ **SUPPORT DE FIXATION SOUS POUTRELLE I**

🇬🇧 Under I beam clamps

🇪🇸 Soporte de fijación bajo viga IPE/N

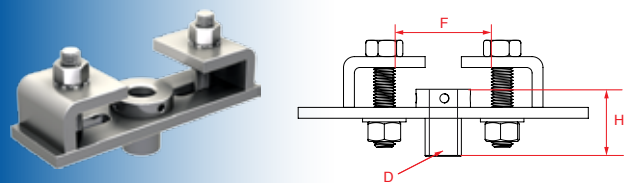

📏	ref	D	H	F
3530	3537	M10	35	IPE 80 - 160
5040	5047	M12	35	IPE 80 - 160
6255	6262	M14	35	IPE 80 - 160
8570	8577	M20	40	IPE 80 - 160

■ ■ **SUPPORT DE FIXATION SOUS POUTRELLE I LARGE**

🇬🇧 Under large I beam clamps

🇪🇸 Soporte de fijación bajo viga IPE/N ancha

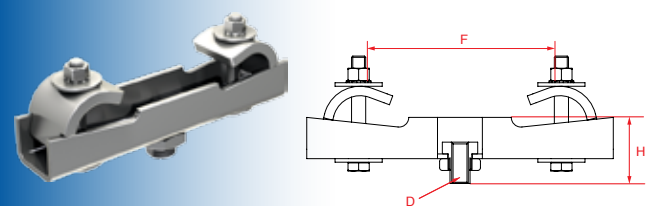

📏	ref	D	H	F
6255	9000TPV	M14	56	IPE 100 - 300
8570	9000TPVR	M20	65	IPE 100 - 300

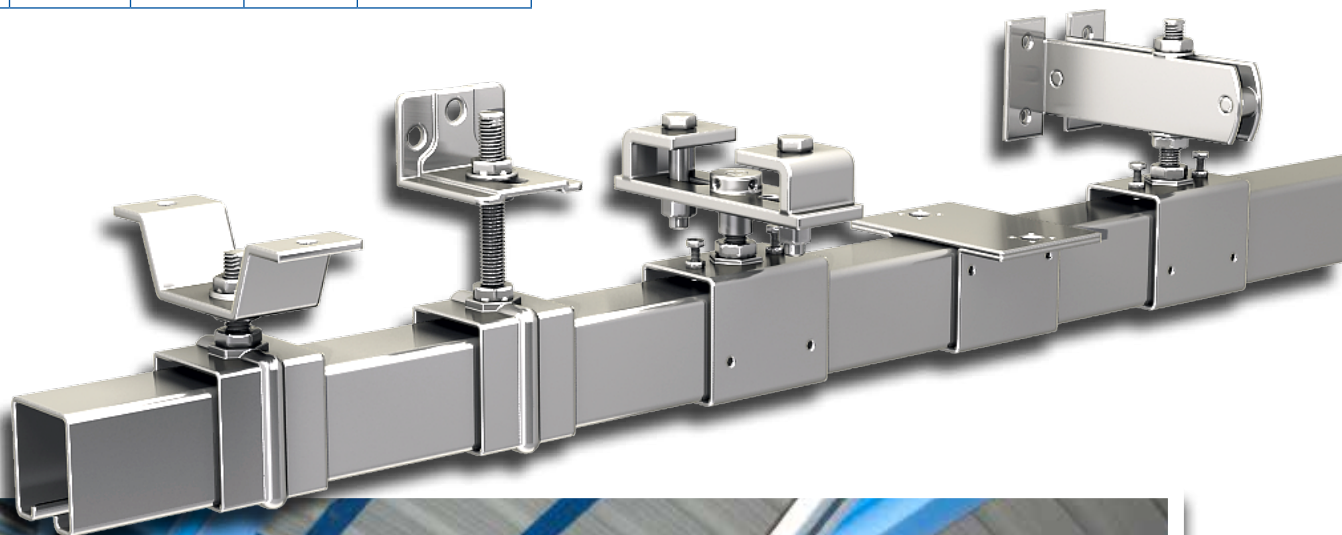



■ Désignation ■ Description ■ Designación		ref	kg			Ø	H	L
---	--	-----	----	--	--	---	---	---

	■ CHARIOTS AVEC GALETS NYLON									
	■ Trolley with Nylon rollers ■ Carro con ruedas nailón	2525	722	10	d	l	8.2	14		63
	■ CHARIOT À 2 GALETS									
	■ Trolley with 2 rollers ■ Carro de 2 ruedas	3530	731R	5	a	l	7	58		30
	5040	751R	20	a	l	7	50	40		
	3530	731*	5	d	l	10	25	36		
	5040	751**	20	d	bz	10	25	50		
	6255	761**	40	d	bz	14	36	65		
	3530	2731	10	a	b	10	26	36		
	5040	2751	25	a	b	10	25	50		
	6255	2761A	70	a	b	14	35	65		
	6255	2761	60	bn	bp	14	35	65		
	■ CHARIOTS À 4 GALETS									
	■ Trolley with 4 rollers ■ Carro de 4 ruedas	3530	732*	10	d	l	8.5	35		90
	5040	752**	40	d	bz	8.4	29	104		
	6255	762**	80	d	bz	14	40	136		
	8570	782**	160	d	bz	14	28	156		
	3530	2732	25	a	b	8.5	35	90		
	5040	2752	60	a	b	8.4	29	104		
	6255	2762A	150	a	b	14	39	136		
	8570	2782A	300	a	b	14	28	156		
	6255	2762	125	bn	bp	14	39	136		
	8570	2782	250	bn	bp	14	28	156		





■ **Galets:** d = delrin / a = acier / bn = billes + bandage nylon
■ **Roller:** d = delrin / a = steel / bn = ball bearing + nylon ring
■ **Ruedas:** d = Delrin / a = acero / bn = bolas + aro de nailón

■ **Paliers:** bz = bronze / l = lisse / b = billes / bp = billes de précision
■ **Axle:** bz = bronze / l = smooth axle / b = ball bearing / bp = precision ball
■ **Palieres:** bz = bronce / l = liso / b = bolas / bp = bolas de precisión

 non fourni
 not provided
 no suministrado

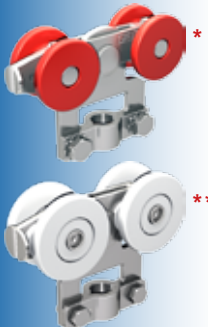
 Désignation  Description  Designación		ref	 kg			Ø	H	L		
---	---	-----	--	---	---	---	---	---	---	---



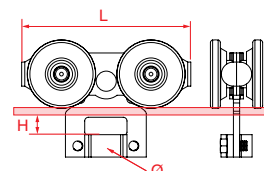

■ ■ CHARIOTS À 4 GALETS

 *  **	 Trolley with 4 rollers  Carro de 4 ruedas	3530	832*	10	d	l	10.5	15	90	8331	8322
		5040	852**	40	d	bz	12.5	17	104	8531	8322
		6255	862**	80	d	bz	15	19	136	8631	8632
		8570	882**	160	d	bz	17	24	156	8731	8732





		3530	2832	25	a	b	10.5	14	90	8331	8322
		5040	2852	60	a	b	12.5	17	104	8531	8322
		6255	2862A	150	a	b	15	19	136	8631	8632
		8570	2882A	300	a	b	17	24	156	8731	8732
		8570	2882S	400	a	bp	21	24	156	8831S	8332S

		6255	2862	125	bn	bp	15	19	136	8631	8632
		8570	2882	250	bn	bp	21	24	156	8331S	8832S

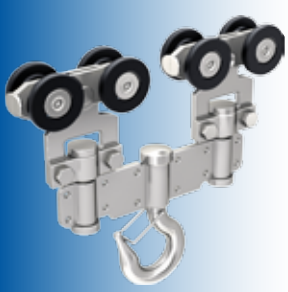

 Désignation  Description  Designación		ref	 kg			H	L	
---	---	-----	--	---	--	---	---	---

■ ■ CHARIOTS DOUBLE À CROCHET

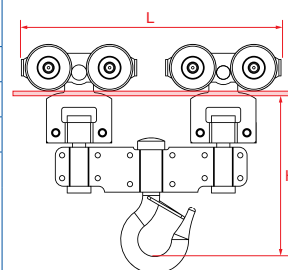

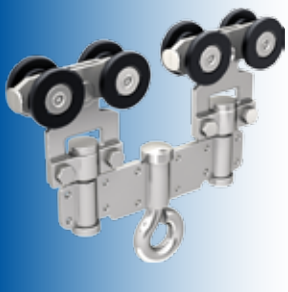

	 Double trolley with hook  Carro doble con gancho	6255	2868	250	bn	bp	204	306	8822S
		6255	2868S	300	a	b	204	306	8822S
		8570	2888	300	bn	bp	193	326	8822S
		8570	2888S	500	a	bp	193	326	8822S



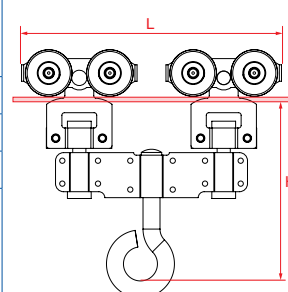



■ ■ CHARIOT DOUBLE À ANNEAU

	 Double trolley with ring  Carro doble con argolla	6255	2869	250	bn	bp	187	306	8821S
		6255	2869S	300	a	b	187	306	8821S
		8570	2889	300	bn	bp	176	326	8821S
		8570	2889S	500	a	bp	176	326	8821S



   **Galets:** d = delrin / a = acier / bn = billes + bandage nylon
 **Roller:** d = delrin / a = steel / bn = ball bearing + nylon ring
 **Ruedas:** d = Delrin / a = acero / bn = bolas + aro de nailón

   **Paliers:** bz = bronze / l = lisse / b = billes / bp = billes de précision
 **Axle:** bz = bronze / l = smooth axle / b = ball bearing / bp = precision ball
 **Palieres:** bz = bronze / l = liso / b = bolas / bp = bolas de precisión

■ ■ BUTÉES

🇬🇧 Stoppers / 🇪🇸 Topes

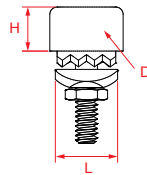

☐	ref	D	H	L
2525	1097	20	12	17

■ ■ BUTÉES

🇬🇧 Stoppers / 🇪🇸 Topes

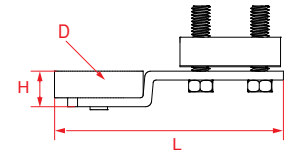
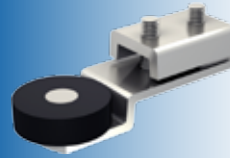

☐	ref	D	H	L
3530	1098	30	12	77.5
5040	1098	30	12	77.5

■ ■ BUTÉES

🇬🇧 Stoppers / 🇪🇸 Topes

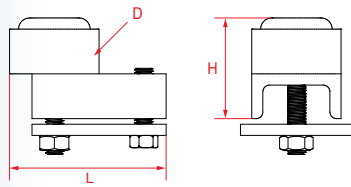

☐	ref	D	H	L
6255	2098	40	45	70
8570	2098	40	45	70

■ ■ ENJOLIVEUR POUR EXTRÉMITÉ DE RAIL

🇬🇧 End rail cap / 🇪🇸 Embellecedor para extremidad de perfil

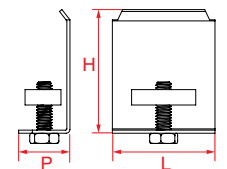

☐	ref	L	H	P
3530	3540	30	34	20
5040	5050	40	48	20
6255	6265	55	60	23
8570	8580	70	82	23

■ ■ CROCHETS

🇬🇧 Hooks / 🇪🇸 Ganchos

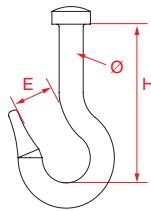

☐	ref	Ø	E	H	📊
3530	8322	10	13	61	20
5040	8522	12	18	72	40

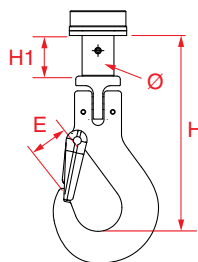

☐	ref	Ø	E	H	H1	📊
6255	8632	14	27	116	19	150
8570	8732	16	27	122	25	300
8570	8832S	20	27	123	25	500

■ ■ ANNEAUX

🇬🇧 Rings / 🇪🇸 Argollas

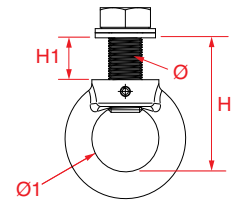

☐	ref	Ø	Ø1	H	H1	📊
3530	8331	10	25	48	13	25
5040	8531	12	29	57	16	60
6255	8631	14	30	60	19	150
8570	8731	16	35	73	25	300
8570	8831S	20	40	80	25	500



Porte câble

Cable carriers / Carros porta cables

Désignation Description Designación		ref	kg				MAX	H	L
A 	■ ■ CHARIOT D'ENTRAÎNEMENT								
	Drive trolley	2525	423P	10	d	l	45x14	66	223
	Carro de arrastre	3530	2433P	25	a	b	45x20	43	197
		5040	2453P	50	a	b	70x20	35	204
		6255	2463P	50	bn	bp	70x20	64	200
	8570	2483P	50	bn	bp	70x20	56	200	
B 	■ ■ CHARIOT À SUPPORT OSCILLANT								
	Trolley with oscillating support	2525	422P	10	d	l	45x14	66	63
	Carro con soporte oscilante	3530	2432P	25	a	b	45x20	33	90
		5040	2452P	50	a	b	70x20	56	104
		6255	2462P	50	bn	bp	70x20	64	200
	8570	2482P	50	bn	bp	70x20	40	156	
C 	■ ■ SUSPENSION FIXE D'EXTRÉMITÉ								
	Fixed end suspension	2525	9414P	10			45x14		68
	Suspensión fija de extremidad	3530	9434PS	25			70x20		68
		5040	9434PS	50			70x20		68
		6255	9454PS	50			70x20		68
	8570	9454PS	50			70x20		68	

Galets: d = delrin / a = acier / bn = billes + bandage nylon
Roller: d = delrin / a = steel / bn = ball bearing + nylon ring
Ruedas: d = Delrin / a = acero / bn = bolas + aro de nailón

Paliers: bz = bronze / l = lisse / b = billes / bp = billes de précision
Axle: bz = bronze / l = smooth axle / b = ball bearing / bp = precision ball
Palieres: bz = bronce / l = liso / b = bolas / bp = bolas de precisión

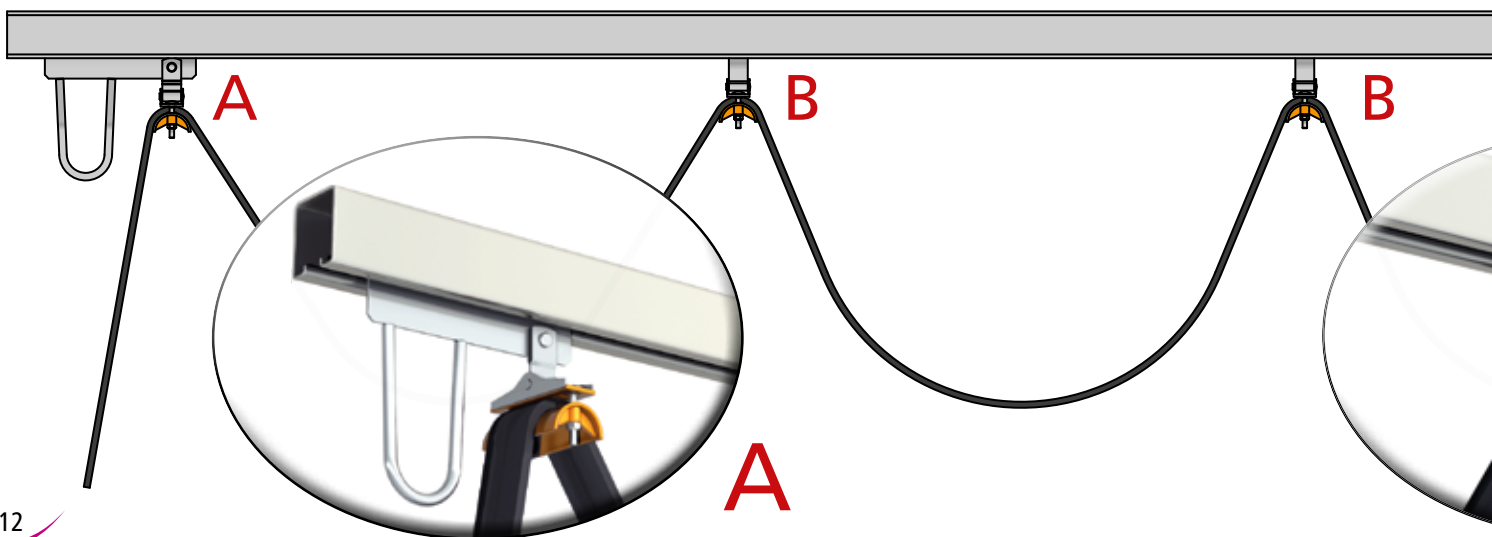

	Désignation Description Designación	ref	kg			MAX	H	L		
A 	■ ■ CHARIOT D'ENTRAÎNEMENT									
	Drive trolley Carro de arrastre	2525	423R	10	d	l	10≥Ø≥20	97	223	
		3530	2433R	15	a	b	10≥Ø≥25	74	197	
		5040	2453R	20	a	b	10≥Ø≥25	67	204	
		6255	2463R	20	bn	bp	10≥Ø≥25	96	200	
		8570	2483R	20	bn	bp	10≥Ø≥25	88	200	
B 	■ ■ CHARIOT À SUPPORT OSCILLANT									
	Trolley with oscillating support Carro con soporte oscilante	2525	422R	10	d	l	10≥Ø≥20	97	63	
		3530	2432R	15	a	b	10≥Ø≥25	65	90	
		5040	2452R	20	a	b	10≥Ø≥25	88	104	
		6255	2462R	20	bn	bp	10≥Ø≥25	83	136	
		8570	2482R	20	bn	bp	10≥Ø≥25	66	153	
C 	■ ■ SUSPENSION FIXE D'EXTRÉMITÉ									
	Fixed end suspension Suspensión fija de extremidad	2525	9414R	10			10≥Ø≥20		68	
		3530	9434R	15			10≥Ø≥25		68	
		5040	9434R	20			10≥Ø≥25		68	
		6255	9454R	20			10≥Ø≥25		68	
		8570	9454R	20			10≥Ø≥25		68	

Galets: d = delrin / a = acier / bn = billes + bandage nylon
Roller: d = delrin / a = steel / bn = ball bearing + nylon ring
Ruedas: d = Delrin / a = acero / bn = bolas + aro de nailón

Paliers: bz = bronze / l = lisse / b = billes / bp = billes de précision
Axle: bz = bronze / l = smooth axle / b = ball bearing / bp = precision ball
Palieres: bz = bronce / l = liso / b = bolas / bp = bolas de precisión

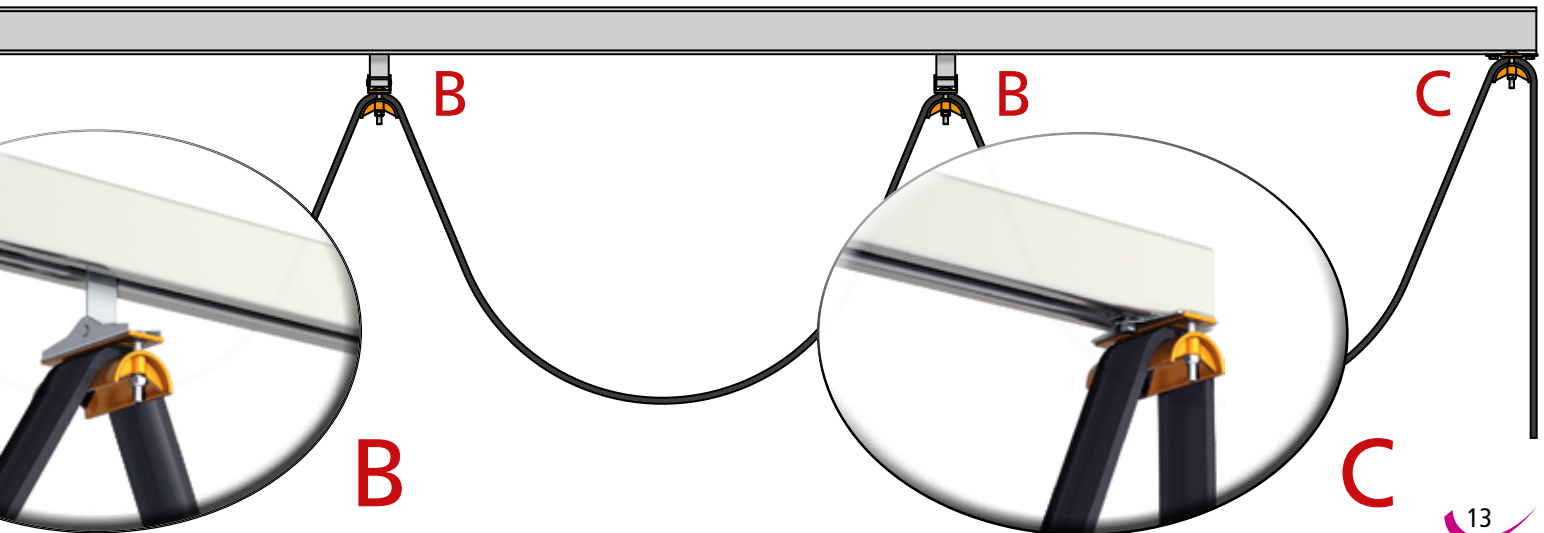



Porte câble

Cable carriers / Carros porta cables

EXEMPLES / EXAMPLES / EJEMPLOS

PLAQUETTE PORTE CÂBLE ROND

Extension for round cable carriers

Alargo porta cable redondo

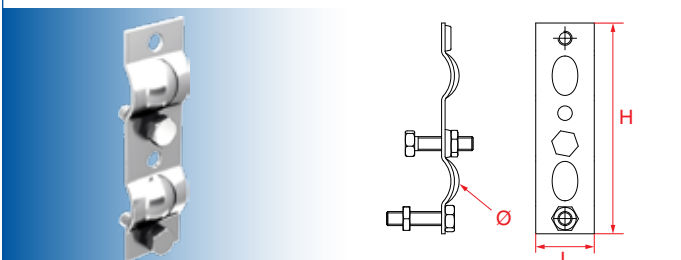

ref	Ø	H	L	
2525 → 8570	410	10 ≥ Ø ≥ 25	90	25

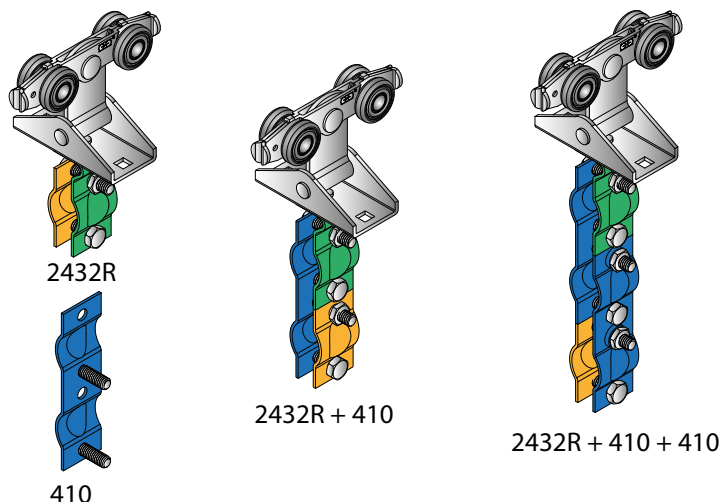

PORTE CÂBLE ACIER NU

Steel cable carriers

Porta cable acero

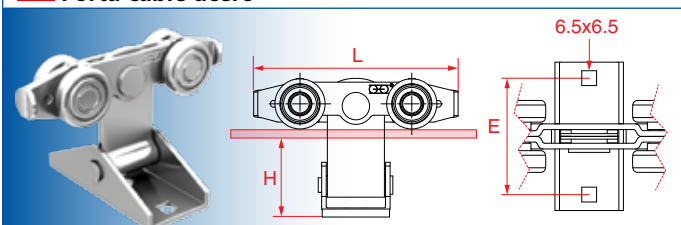

ref	kg	d	l	H	L	E	
2525	426	10	d	l	64	63	51
3530	2436	15	a	b	31	90	51
5040	2456	20	a	b	55	104	51
6255	2466	20	bn	bp	50	136	51
8570	2486	20	bn	bp	39	156	51



KIT PORTE TUBE pour porte câble acier nu

Pipe hanger for steel cable carrier above

KIT porta tubo para porta cable acero

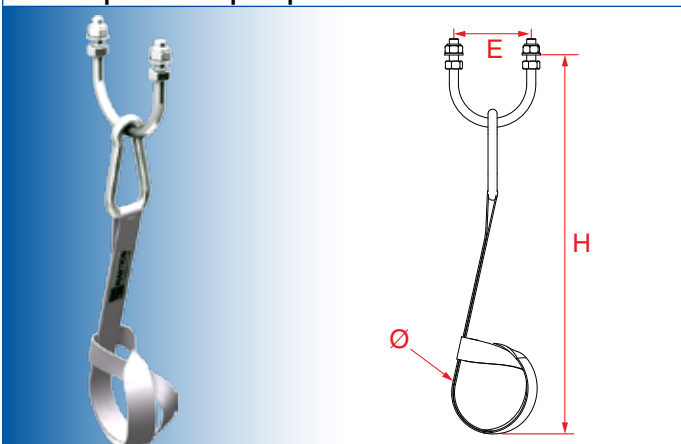

ref	Ø	H	E	
2525 → 8570	99402T	80 max	250	51

KIT PORTE TUBE pour chariots (p.9)

Pipe hanger for trolleys (p. 9)

KIT porta tubo para carros (p. 9)

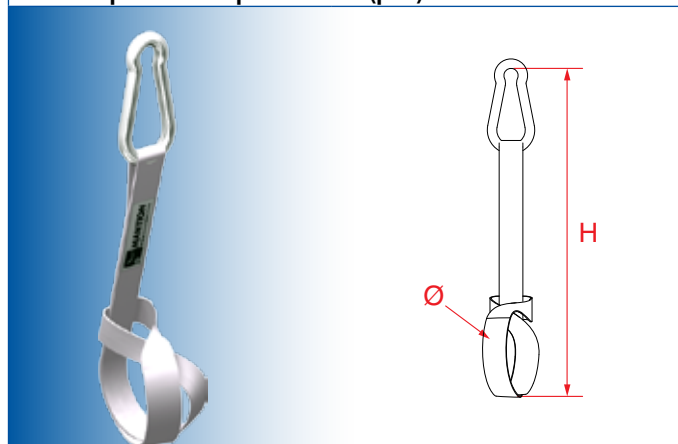

ref	Ø	H	
2525 → 8570	9402T	80 max	205

Galets: d = delrin / a = acier / bn = billes + bandage nylon

Roller: d = delrin / a = steel / bn = ball bearing + nylon ring

Ruedas: d = Delrin / a = acero / bn = bolas + aro de nailón

Paliers: bz = bronze / l = lisse / b = billes / bp = billes de précision

Axle: bz = bronze / l = smooth axle / b = ball bearing / bp = precision ball

Palieres: bz = bronce / l = liso / b = bolas / bp = bolas de precisión

www.mantion-manutention.com

■ Notre programme de calcul est disponible sur :
www.mantion-manutention.com
et vous permet d'élaborer votre poutre roulante.
Demandez-nous votre mot de passe/ Login pour vous y connecter et avoir accès aux fiches techniques.

■ Our programm to calculate your crane is available on:
www.mantion-manutention.com
Ask us for Login and password in order to use it and have acces to the online technical documentation.

■ Nuestro programa de cálculo está disponible en:
www.mantion-manutention.com
**Le permite diseñar Ud. Mismo su puente ligero.
Pidan sus accesos /contraseña para conectarse y tener acceso a la fichas técnicas.**



■ Grâce à son profil HERCULE, Mantion propose aussi une large gamme de matériel de monorail:
• convoyeur motorisé, stations élévtrices...
• aiguillages, plaques tournantes, distributeurs indexés...

DEMANDEZ NOTRE CATALOGUE 821

■ Thanks the HERCULE track, Mantion propose also a large range of material for monorail:
• motorised conveyors, drop sections...
• switches, turn-tables...

ASK OUR CATALOGUE 821

■ Mediante su perfil HERCULE, Mantion ofrece igualmente una amplia gama de productos para mono viga:
• Transportador motorizado aéreo, estaciones elevadoras...
• Cambio de vías, placas giratorias, distribuidores indizados...

PIDAN NUESTRO CATÁLOGO 821





MANTION

MANUTENTION

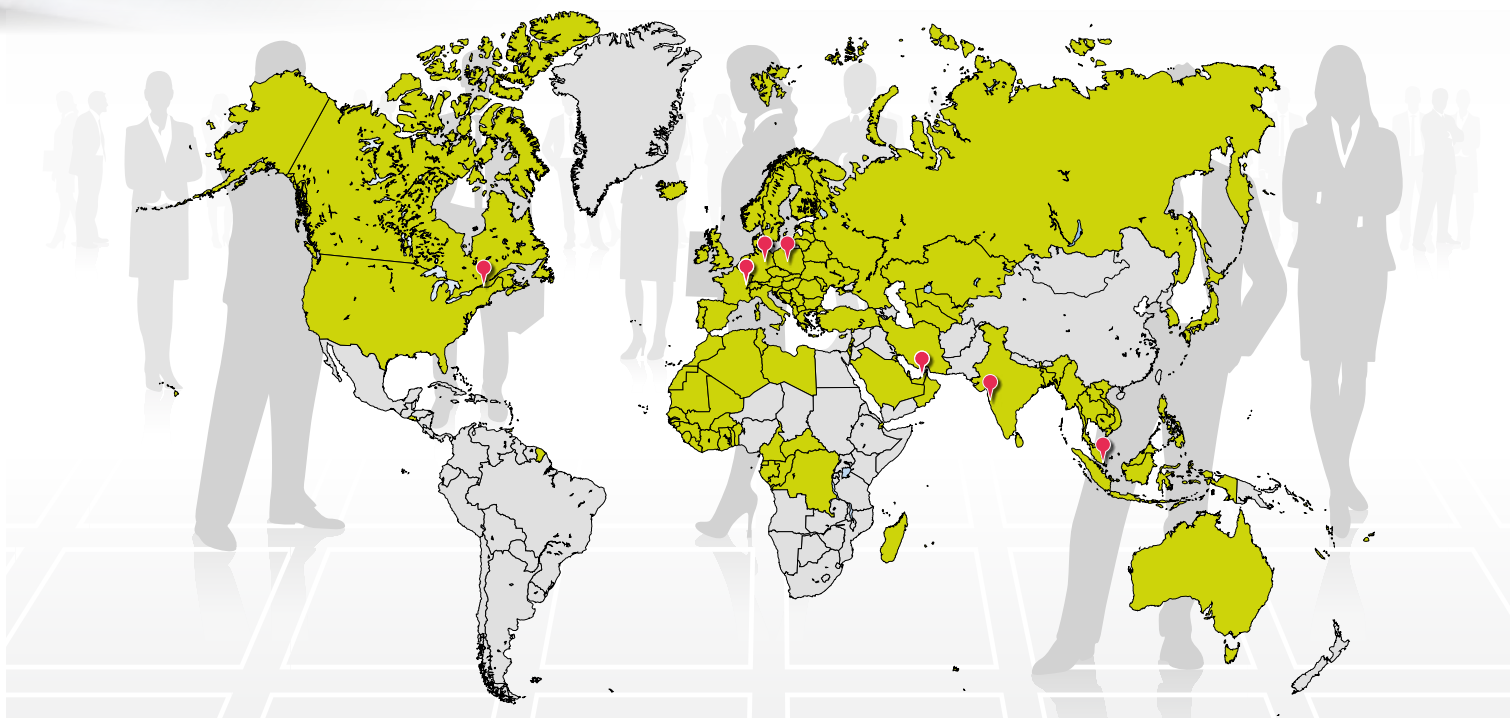

ALLEMAGNE / AUTRICHE MANTION BAUBESCHLÄGE GMBH

Dieselstraße 18
D-42579 HEILIGENHAUS
Tél. + 49 2056 58 26 90
Fax. + 49 2056 58 26 99
Email : info@mansion.de
www.mansion.de

MOYENT ORIENT DUBAI BRANCH OFFICE

Jafza South, unit no. S101 23 O 032,
Jebel Ali Free Zone, Dubai, UAE
Tél. + 971 56 174 58 44
Email : export@mansion.com
www.mansion.com

ASIE DU SUD-EST MANTION SOUTH EAST ASIA

Pte. Ltd. of 4 Battery Road,
#25-01 Bank of China Building,
Singapore 049908
Mobile. + 65 9147 8440
Email : export@mansion.com
www.mansion.com

EUROPE DE L'EST VALCOMP SP Z.O.O

ul Boruty 2a
PL-03 769 WARSZAWA
Tél. + 48 22 818 77 22
Fax. + 48 22 818 99 78
Email : biuro@valcomp.com.pl
www.valcomp.com.pl

INDE MUMBAI BRANCH OFFICE

G-19, Rez-de-chaussée,
T.V. Estate, 248/A, S.K. Ahire Marg.
Worli, Mumbai. 400 033. India.
Mobile. + 91 9819 30 38 78
Email : a.gala@mansion.com
www.mansion.com

AMERIQUE DU NORD MANTION CANADA

6-360 boul. Séminaire N
Saint Jean sur Richelieu
Québec J3B 5L1
Tél. Canada + 1 855 754-3187
Tél. USA + 1 866 626-8466
E-mail : adminna@mansion.com
www.mansion.ca

MANTION SAS

7 rue Gay Lussac
F-25000 BESANÇON
Tel +33 3 81 50 56 77
Fax +33 3 81 53 29 76
E-mail : mantion@mansion.com

