

BUSE DE Puits PERFOREE A EMB.

Ø Int. 0,80 m

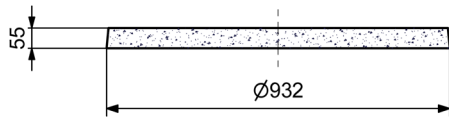

COUVERCLE PLEIN
BUSE DE Puits Ø 0,80 m

Code Article : 461016

Poids : 90 Kg

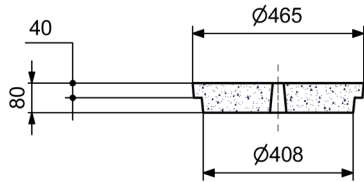

COUVERCLE
BUSE DE Puits Ø 0,80 m
AVEC TAMPON RENFORCES

Code Article : 461020

Poids : 133,5 Kg

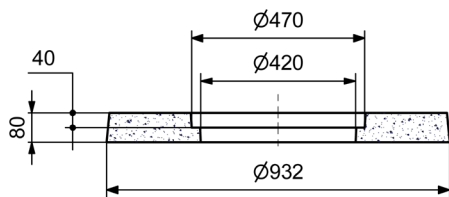
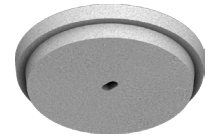

COUVERCLE
BUSE DE Puits Ø 0,80 m
AVEC TAMPON

Code Article : 461010

Poids : 83,6 Kg

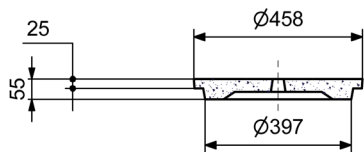
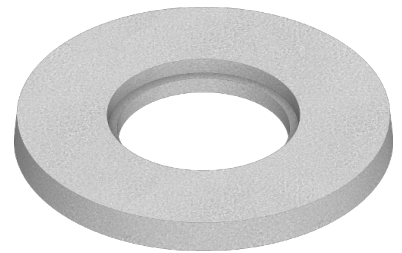

BUSE DE Puits A EMBOITEMENTS
Ø Int. 0,80 m Ht. 0,60 m
PERFOREE

Code Article : 460010

Poids : 266,8 Kg

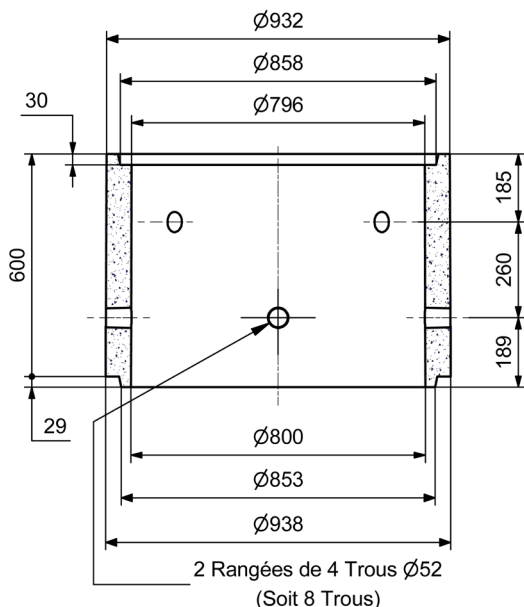
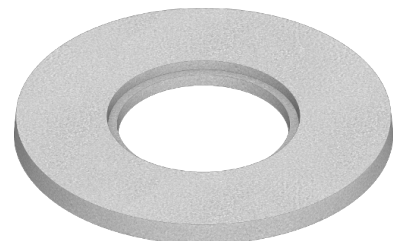
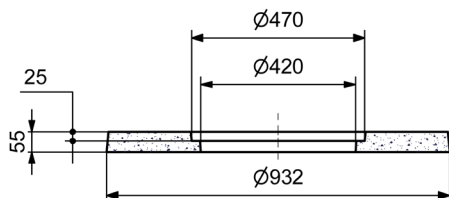
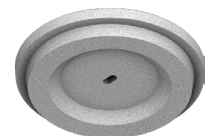

SAS R. THEBAULT

Siège social et usine :

8, rue des Glénan - ZI de Saint-Eloi - 29800 PLOUEDERN

Tel. 02 98 21 63 63 - Fax : 02 98 21 34 11

Usines à : Mauron (56430) et Verneuil S/Avre (27130)



Version du 30/08/2017