

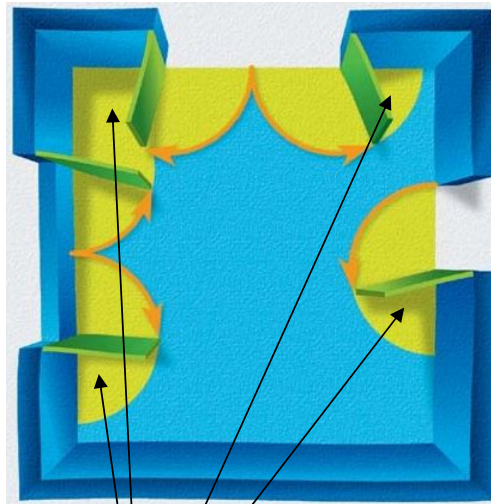

Présentation châssis
GOLD BASE

L'idée Scrigno

Solution traditionnelle "les blocs-portes"



Espaces non utilisables

Espace perdu...

Solution innovante "les portes coulissantes"



Toute la surface est disponible

Espace optimisé !

L'idée Scrigno

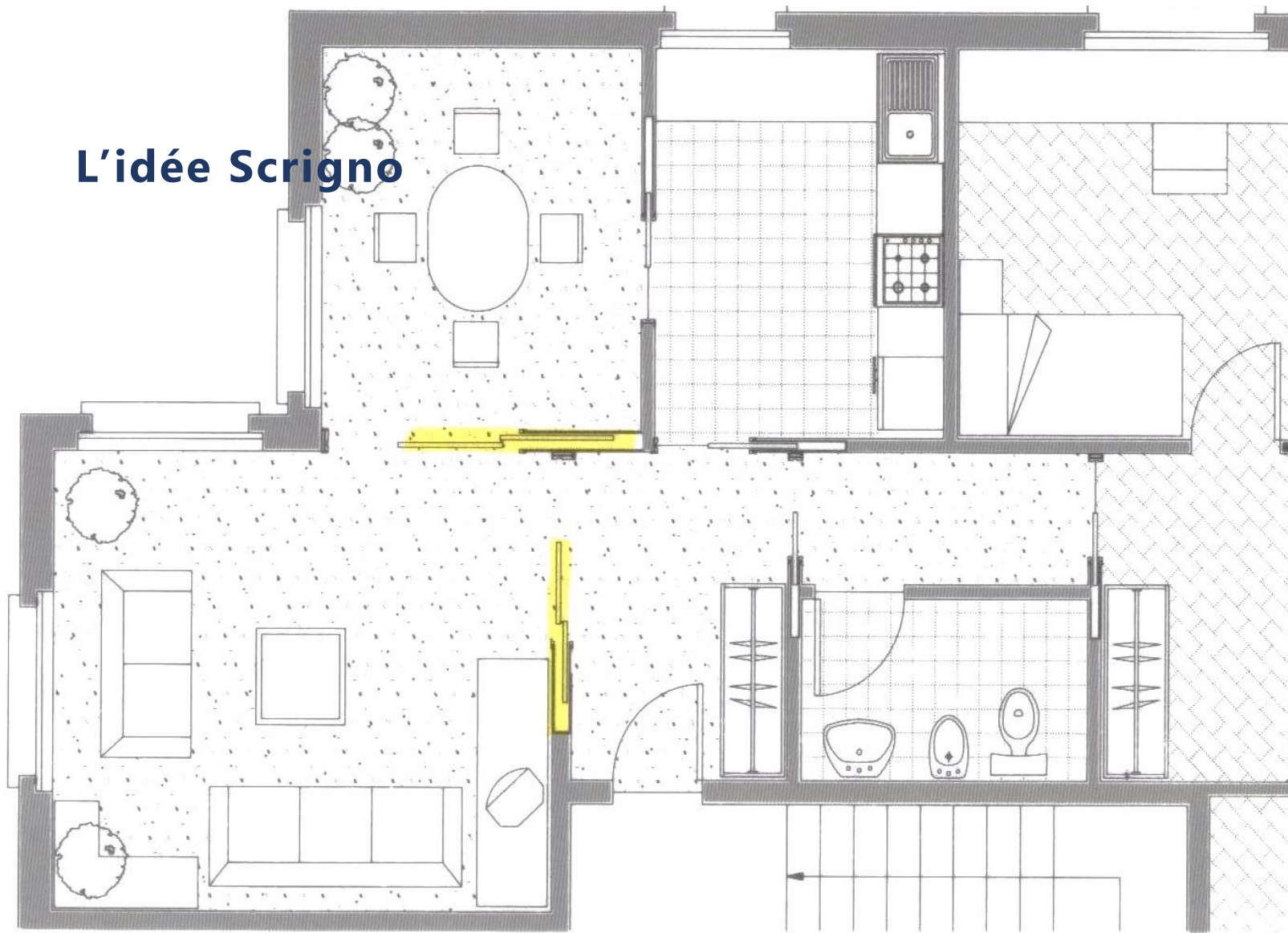

L'idée Scrigno: *Simple !*

Gagner de la place

Faire apparaître et disparaître les portes dans la cloison

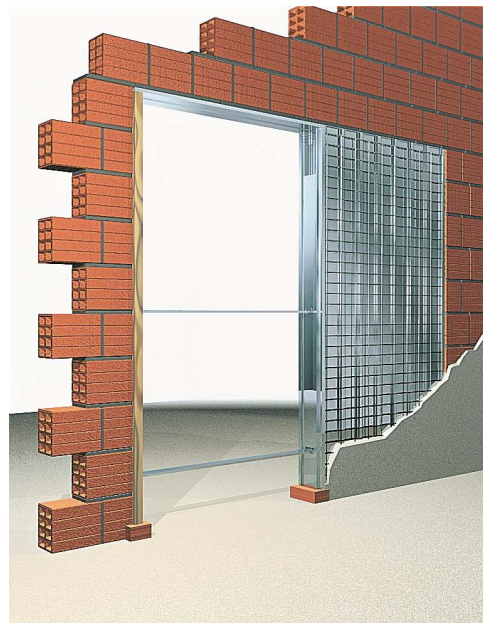



Un châssis à galandage ?

Les châssis à galandage SCRIGNO

- Gamme GOLD:

Châssis assemblés

Version enduit

Version plaque de
plâtre

SCRIGNO GOLD

SCRIGNO®

CE QUE VOS CLIENT TROUVENT DANS L'EMBALLAGE

1. CAISSON (châssis)
2. RAIL
3. PRE-CADRE BOIS
4. VIS DE 19 mm (pour version plaques de plâtre)
5. ECARTEURS DE POSE
6. COULISSEAU (pour version pl de plâtre)
7. BRIDE DE JONCTION (dans châssis doubles)



ELEMENTS MODULAIRES EN ALUZINC

5 fois plus résistant
qu'une galvanisation



SCRIGNO® Gold

STABILITE'

Les modules en tôles – épaisseur 5/10 mm – sont dotés d'un double emboitage. Avec des jonctions toutes les 20cm, l'épaisseur total est de 15/10 mm.

La quantité de tôle est 25% supérieur à une solution équivalente lisse

RESULTAT : UNE TRES GRANDE STABILITE' DES FLANCS AUX POIDS SUSPENDUES

* Certifiée selon la norme UNI 8201:1981



RAIL EN ALUMINIUM ANODISE
Épaisseur 20/10 - 1300 grammes/mètre linéaire
Anti torsion / anti flexion



**LE RAIL EST RECOUVERT D'UN
FILM PLASTIQUE POUR LE
PROTEGER PENDANT LA DUREE
DES TRAVAUX**

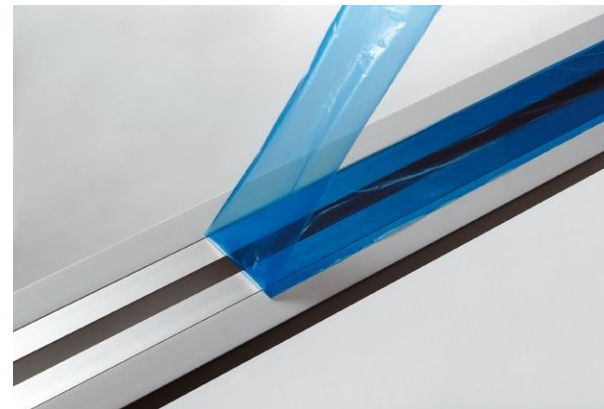

**SCRIGNO
ESTAMPILLE DANS LE RAIL**



L'EMBALLAGE

Nouvel packaging depuis fin 2019



ancien

Double frein de serie

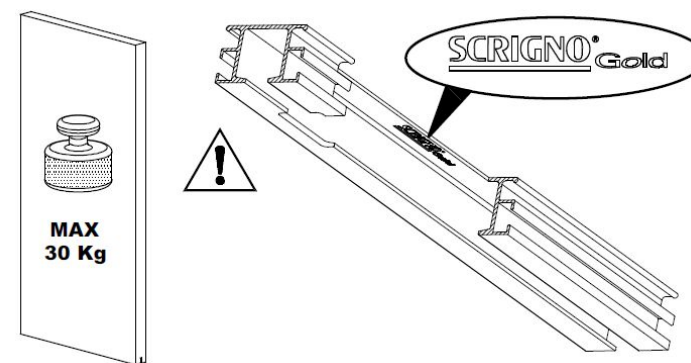
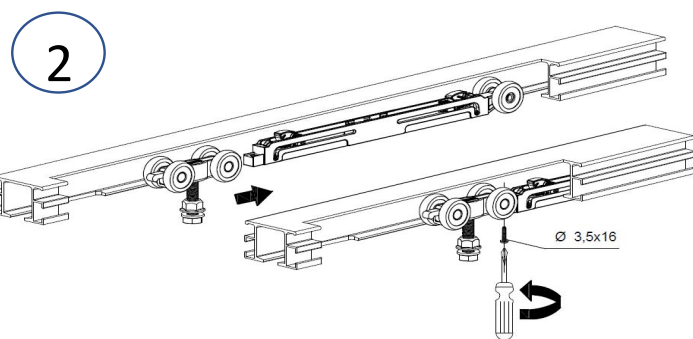
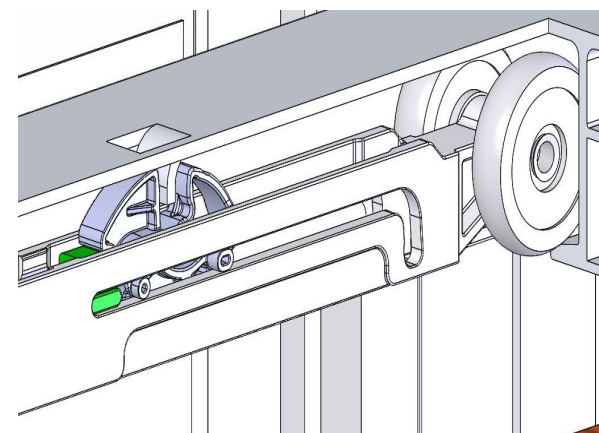
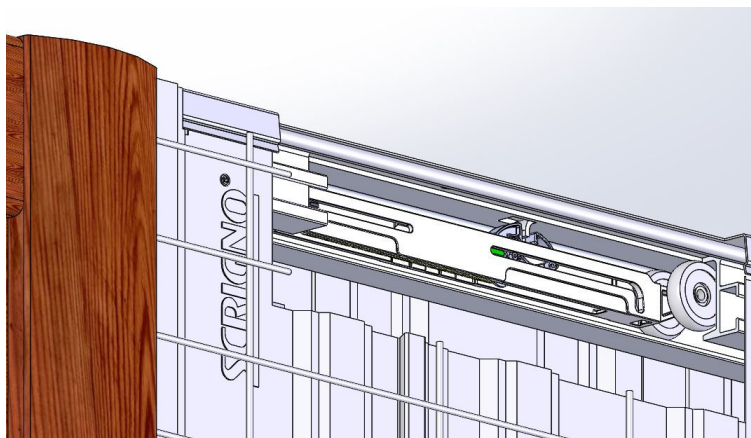

KIT CHARIOT
Structure en métal
4 GALETS sur roulements à billes avec roues en delrin
- PORTEE DE 120 Kg

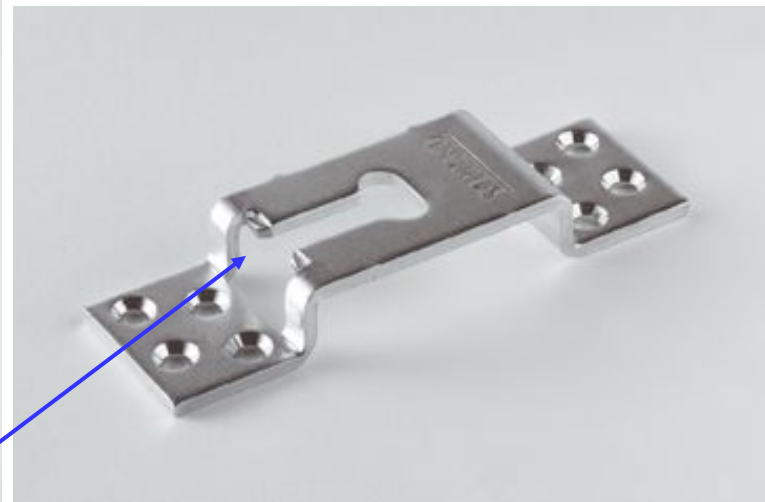

ETRIER DE SUSPENSION CONCU POUR FACILITER LA POSE ET DEPOSE DE LA PORTE

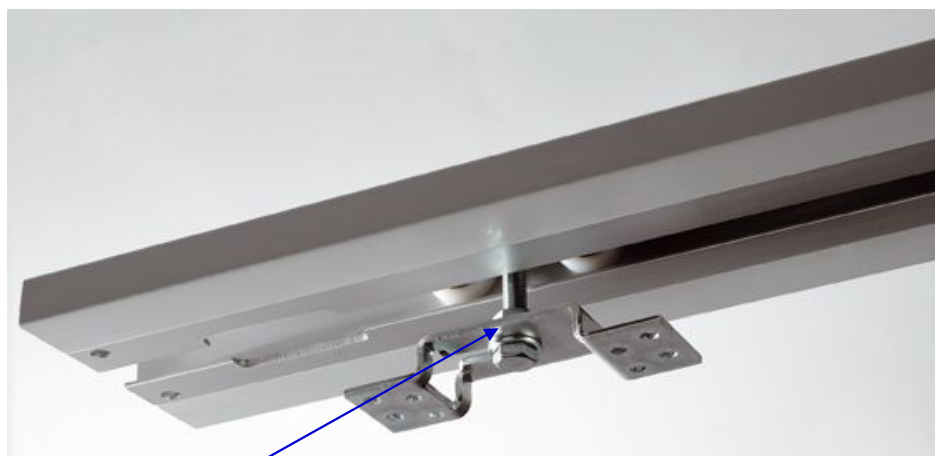

Tige filetée avec écrou+contre-écrou pour un réglage de la porte en hauteur (jeu de 15 mm)

ASSEMBLAGE DU CHASSIS

1. INSERER LE RAIL DANS SON LOGEMENT
2. QUAND LE RAIL ARRIVE EN POSITION CORRECTE, LE RESSORT SE CLIPPE ET LE BLOQUE AUTOMATIQUEMENT

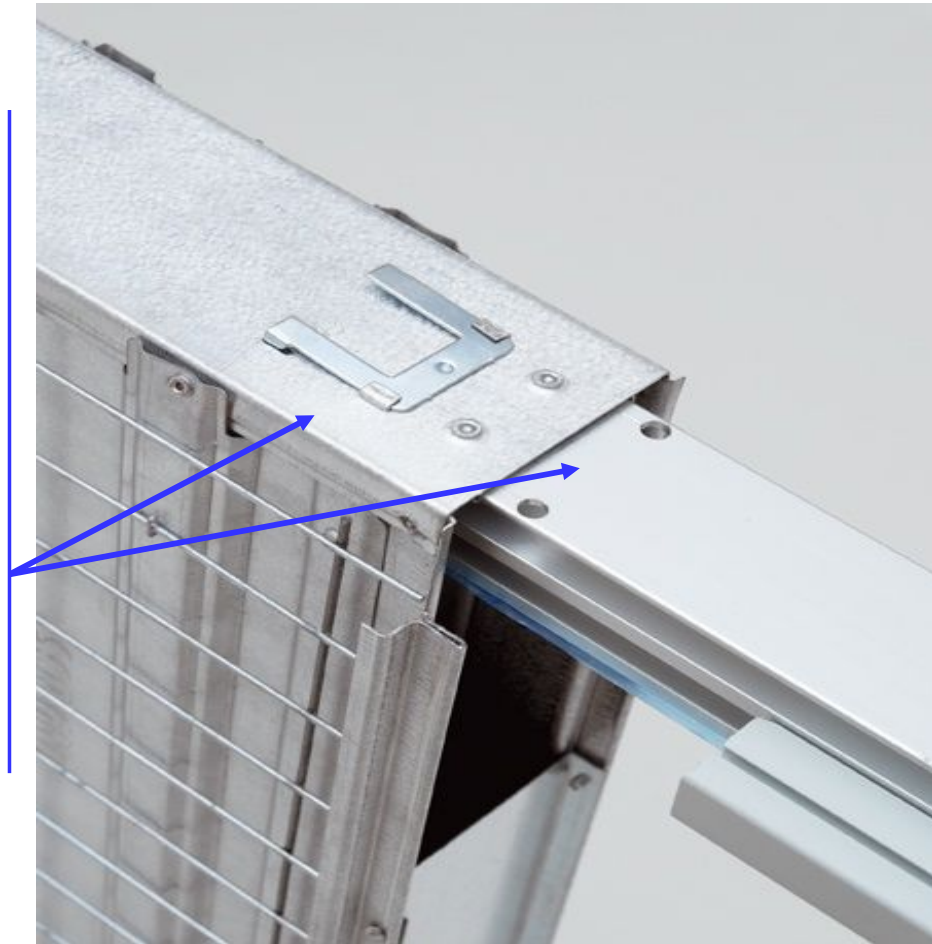

MISE EN PLACE DES ECARTEURS DE POSE



LISSES HORIZONTALES POUR VISSAGE PLAQUES DE PLATRE (BA13)

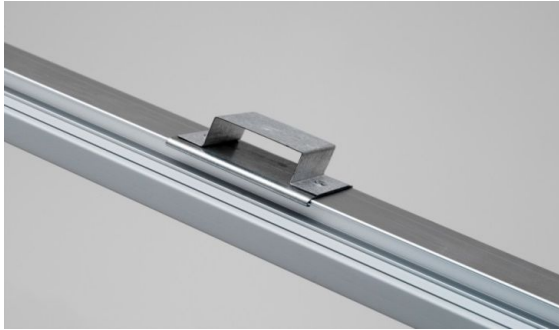

**ATTENTION ! Pour la fixation des plaques de plâtre, utiliser des vis de 19 mm
(fournies)**



Mise en place du châssis

(tenir compte des cotes sol fini)

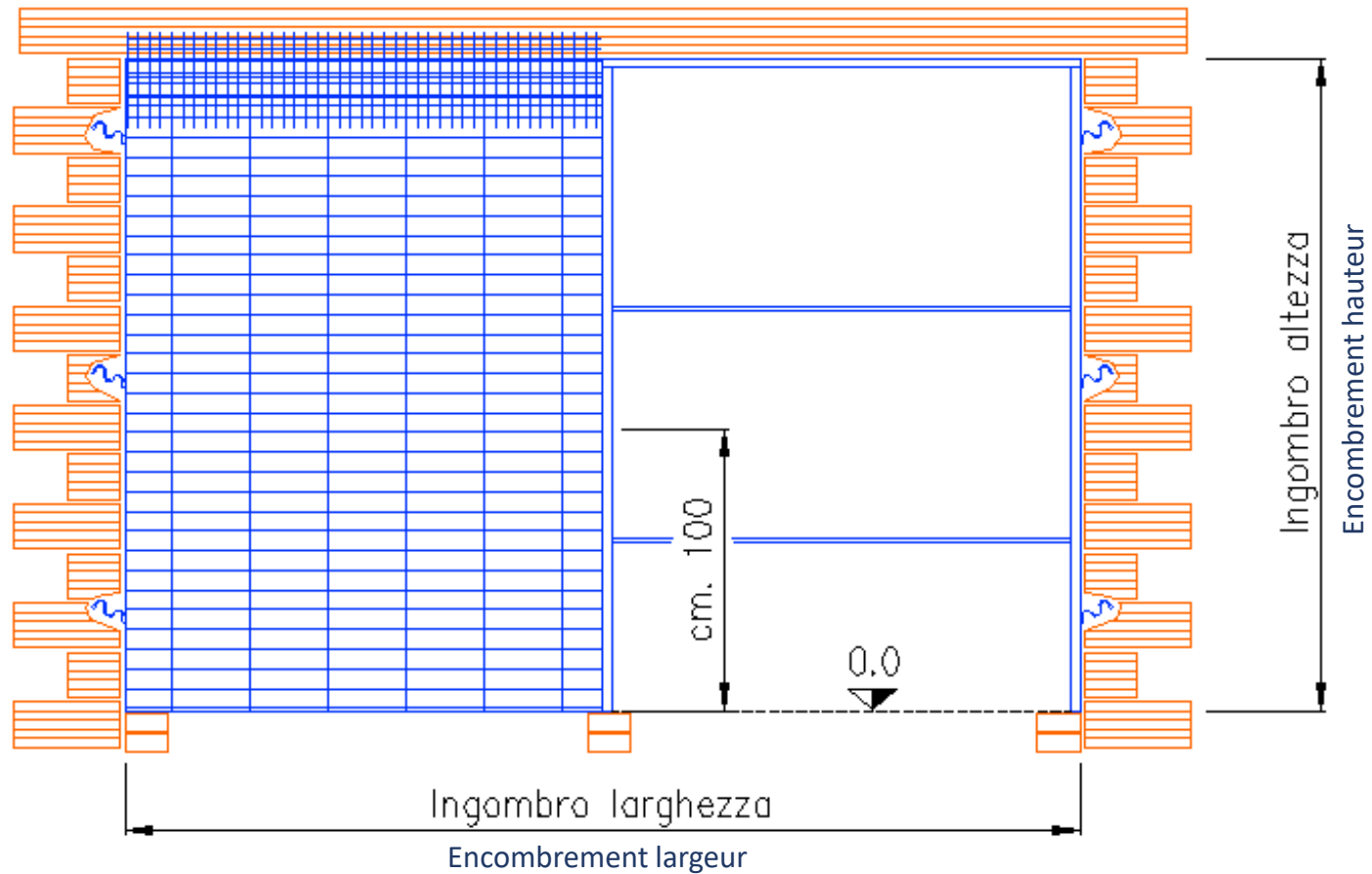

Finition de la cloison

Cloison à enduire

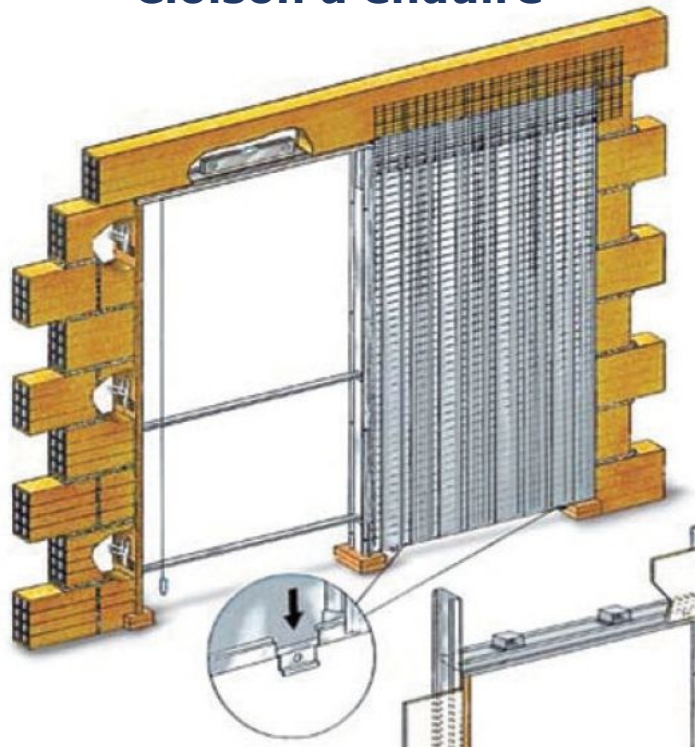

Cloison en plaques de plâtre

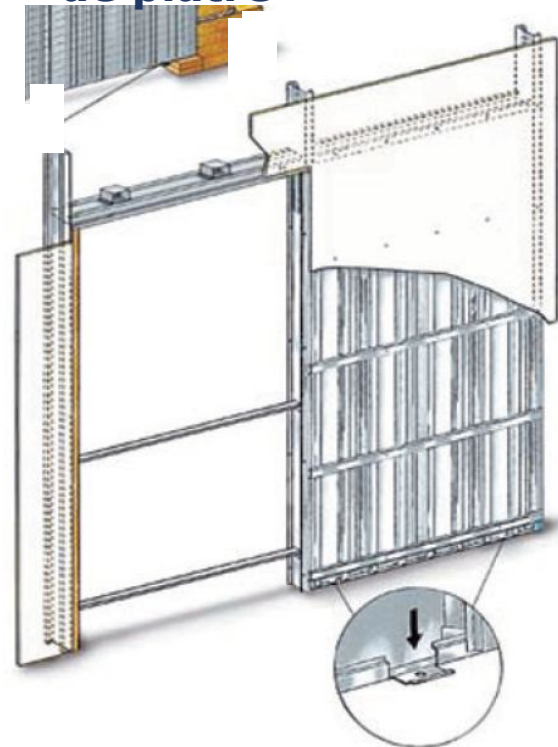

Dimensions : cloison 100mm et 125mm

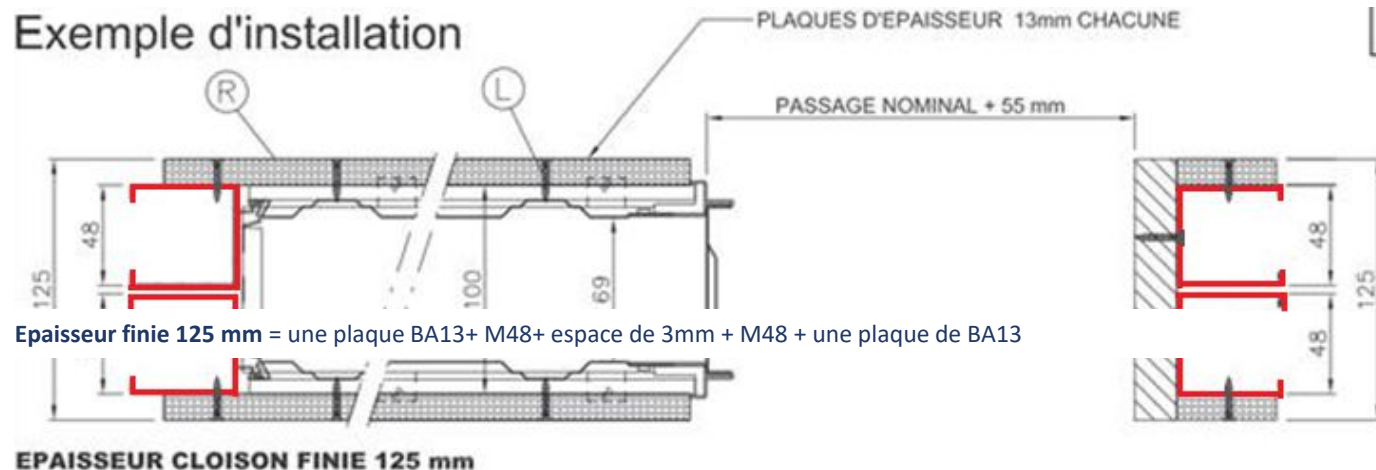

Épaisseur finie 125 mm = une plaque BA13+ M48+ espace de 3mm + M48 + une plaque de BA13

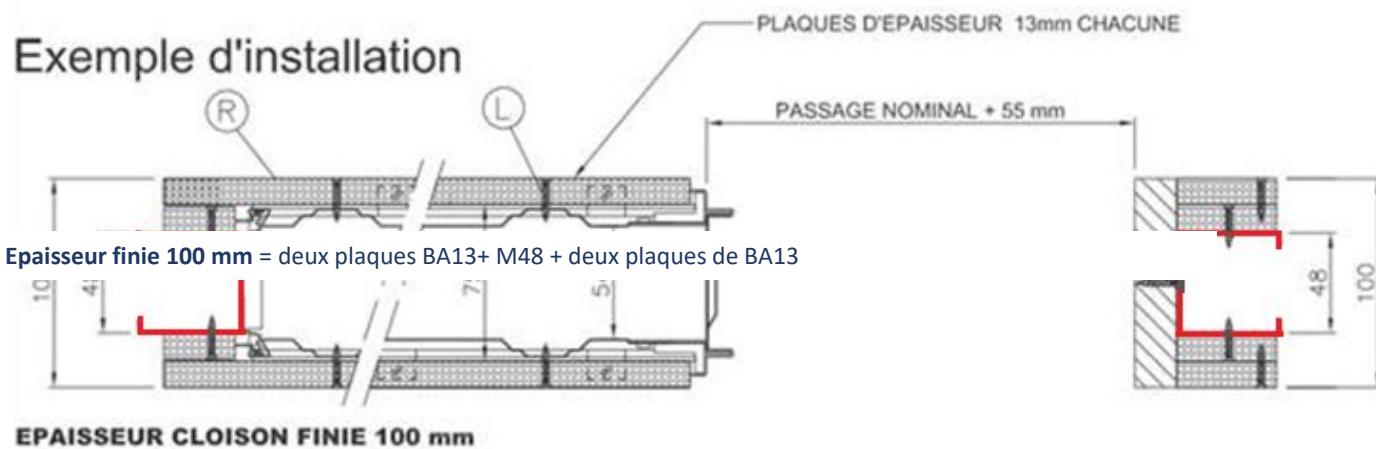

Épaisseur finie 100 mm = deux plaques BA13+ M48 + deux plaques de BA13

Dimensions: encombrement

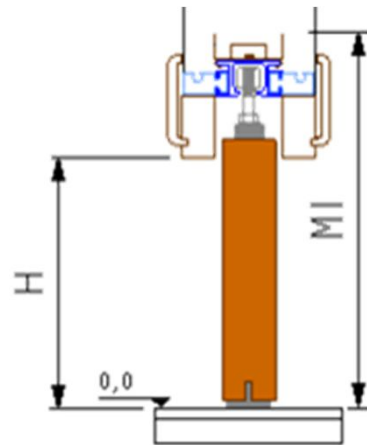
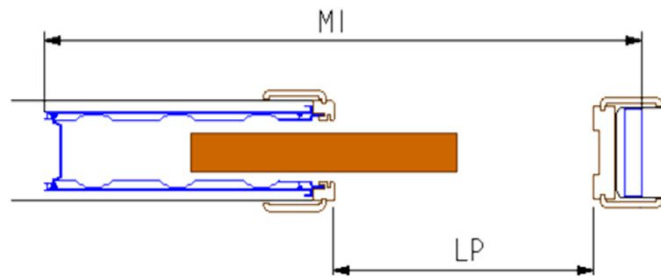

HAUTEUR et LARGEUR
nécessaires au positionnement
du châssis

Dimensions: de passage

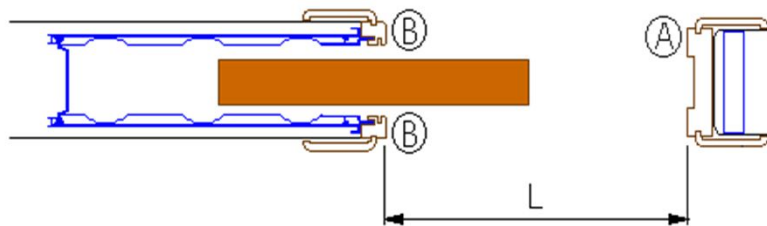

Largeur:
Dimension entre le montant de réception (A) et les profils du kit de finition (B,B)

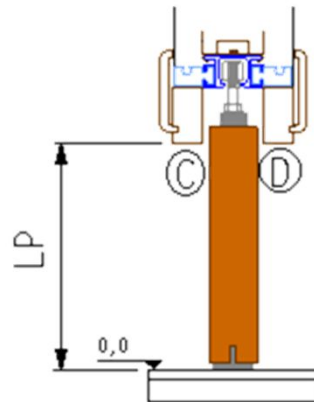

Hauteur :
dimension entre le sol finit (liv.0,0) et les traverses du kit de finition (C, D)

Dimensions: épaisseur cloison

Épaisseur total de la cloison, plaque de plâtre ou enduit

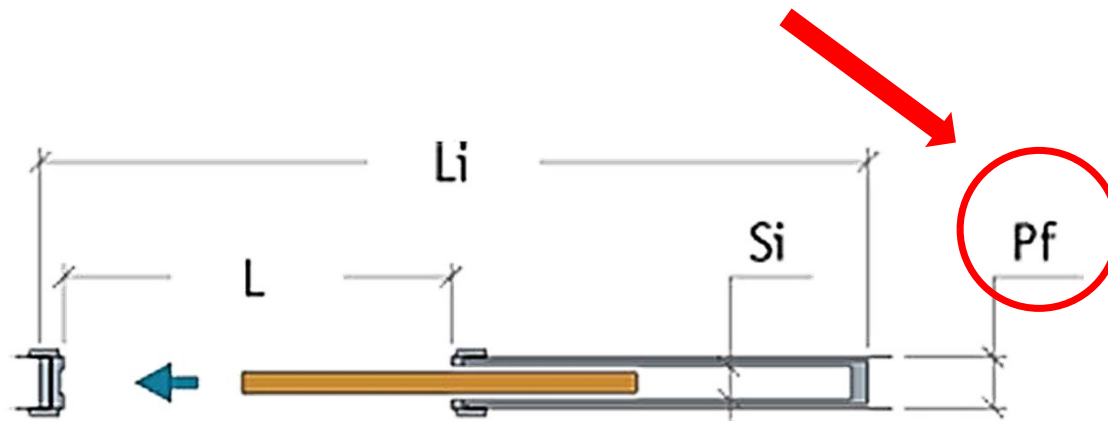

Dimensions: vide interne

Espace disponible à l'intérieur du caisson afin d'assurer le coulissement de la porte (vide interne - 14mm (7+7) = épaisseur max. conseillé du vantail, 40mm pour le standard)

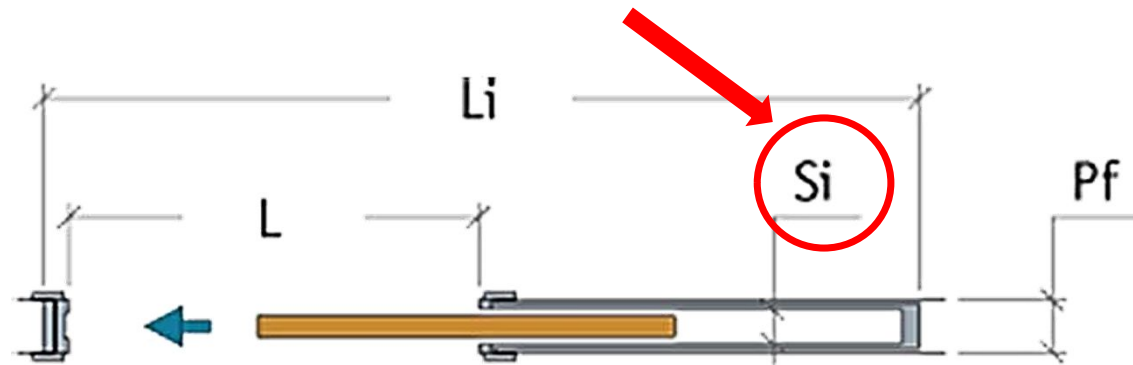

LA QUINCAILLERIE



Le sachet contenant les accessoires pour le montage de la porte à l'intérieur du châssis (évite perte ou vol sur les chantiers)



SCRIGNO Gold

GUIDE BAS

- Profil pré percé pour un positionnement facile et rapide
- Guide réglable
 - en hauteur
 - En épaisseur



POSITIONNEMENT DU CHÂSSIS



Les cotes châssis sont
données pour pose sur sol
fini (caler si sol non fini)

Trait de **niveau à 1 m**
indiqué sur le châssis, ce
qui permet de le caler à la
bonne hauteur



GARANTIES

- **A' VIE** contre la corrosion « perforante » pour tous les composants du châssis construits en tôle d'Aluzinc.
- **20 ANS** pour l'intégrité du kit chariot et du rail en Aluminium anodisé.
- Scrigno garantit que ces châssis à galandage sont produits en conformité selon les standards de production de la norme système de qualité **UNI EN ISO 9002 Ed. 2008**.

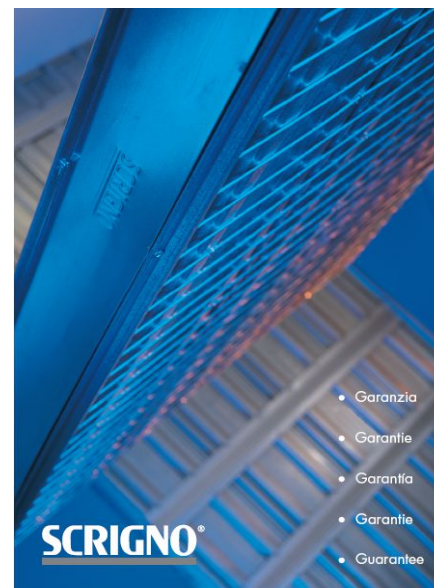

LA QUALITE:

LA GARANTIE ET LES CERTIFICATIONS

DA CONSEGNARE AL PROPRIETARIO DELL'IMMOBILE

SCRIGNO®

Garanzia Scrigno sui controtelai per porte e finestre scorrevoli a scomparsa

Scrigno è società con sistema di qualità certificato **UNI EN ISO 9002 Ed. 1994** per la produzione di controtelai (cassonetti) per porte e finestre scorrevoli a scomparsa nel muro.

Garanzia di integrità.

Scrigno garantisce che i controtelai per porte, finestre, persiane e inferriate scorrevoli sono realizzati in conformità agli standard qualitativi prescritti nell'ambito del sistema di qualità certificato secondo la norma **UNI EN ISO 9002 Ed. 1994**.

Nel caso in cui l'acquirente, ad un primo esame effettuato dopo lo sfontamento del controteatro, dovesse rilevare l'esistenza di un vizio, e Scrigno ne dovesse verificare la sussistenza, avrà diritto alla sostituzione gratuita del controteatro alle seguenti condizioni:

- L'acquirente dovrà denunciare l'esistenza di vizi al Rivenditore Autorizzato Scrigno presso cui ha fatto l'acquisto, **entro venti giorni dalla consegna.**
- Il Rivenditore Autorizzato Scrigno, previa verifica della sussistenza del vizio, dell'esclusione di responsabilità di terzi e previa esibizione della copia del certificato di garanzia da parte dell'acquirente, provvederà alla sostituzione immediata del controteatro oppure garantirà la sostituzione del prodotto nel termine dei 10 giorni.
- La spesa di chiamata del rivenditore e di installazione del controteatro sono a carico dell'acquirente.

Scrigno Srl intende fornire al consumatore che sceglie i controtelai originali Scrigno una ulteriore:

Garanzia 12 anni sui componenti del cassonetto e sul fit corvette.

a) Scrigno garantisce che i componenti del cassonetto, costruiti in lamiera alluzinc, non sono soggetti ad offuscamenti di ruggine per i 12 anni che seguono la data di produzione, se installati in ambienti privati o pubblici comunque destinati alla presenza di persone (da tale garanzia si escludono quindi i controtelai installati in edifici produttivi e di servizio a forte concentrazione acida o salina)

b) Scrigno garantisce il Kit controllo contro le rotture per 12 anni, specificandone la portata massima:
per controtelai per porte: 80 Kg.
per controtelai per serramenti esterni: 180 Kg.

c) Scrigno garantisce per 12 anni l'integrità del binario in alluminio anodizzato.

LA GARANTIE SCRIGNO Caisson garanti à vie Accessoires 20 ANS

Certificate N° IT96/0072

SGS

The Quality Management System of:

SCRIGNO S.r.l.
Via Casale, 975 - 47038 SANT'EREMETE DI SANT'ARCANGELO DI ROMAGNA (RN)

Has been assessed and registered as meeting the requirements of:

ISO 9001 / UNI EN ISO 9001 - Ed. 2000

For the following activities:

Design and production of frames for in wall disappearing sliding doors and windows.

EA Sector: 17

SGS Italia S.r.l. - Sistema di Servizio Certification
Autorizzato/Rappresentativa

First issue: 31/07/1996
Last issue: 03/11/2003

Valid until 03/11/2006 subject to semi annual satisfactory surveillance.
The details of possible exclusions of ISO 9001:2000 requirements are referred to in the Quality Manual of the certified organization.

SGS

SGS Italia S.r.l.
Via O. Ziani, 1/A
37029 VERONA
Tel. 04772001
Fax. 047703000

LA CERTIFICATION DE LA SOCIETE

ISTITUTO GIORDANO s.p.a.
LABORATORIO DI RICERCHE DI FISICA TECNICA

Via Risorgimento, 2
47041 BELLARIA (FO) Italy
Tel. (0541) 343000 (7 linee)
Telex: 320676 IORIT I
Telex: 320413 IADIS I

Aut. Min. (Prov. BA) 0054864/6408
C.C. A.A. 164/100
Aut. Min. (Prov. BA) 0054864/6408
Cap. Soc. Lit. 4.000.000.000 i.l.

CERTIFICATO DI PROVA N. 37617

Luogo e data di emissione: Bellaria, 17 / 07 / 1996

Committente: SCRIGNO S.r.l. - Via Pascoli, 22 - 47040 CERASOLO AUSA DI CORIANO (FO)

Data della richiesta: 14 / 05 / 1996

Data della prova: 16 / 07 / 1996

Oggetto della prova: RESISTENZA ALL'URTO DA CORPO MOLLE PER PARETI INTERNE SEMPLICI SECONDO LA NORMA UNI 8201 PUNTO 2.

Provenienza del campione: dal Committente.

Descrizione del campione (*):

Il campione sottoposto a prova è costituito dal cassonetto in lamiera d'acciaio, avente dimensioni di 80 x 300 cm, di un controteatro a murare per porte scorrevoli a scomparsa, composto dal cassonetto stesso e da un vano aperto, avente dimensioni di 80 x 200 cm.

(*): secondo le prescrizioni del Committente.

Comp. Ed. Evis. Il presente certificato di prova è composto da n. 4 fogli.

LA CERTIFICATION DU PRODUIT

GOLD BASE

- Principal produit de toute l'offre Scrigno
- Épaisseur cloison 100 mm
- Disponible
 - en version simple et double
 - en version enduit ou plaque de plâtre
 - en H. standard 2040 et 2100 mm
 - en sur mesure en L. et H.

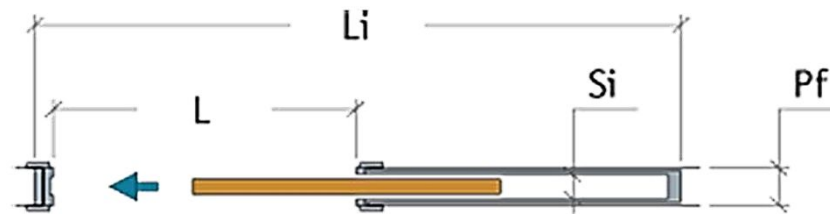

SCRIGNO GOLD: L'ampleur de la gamme

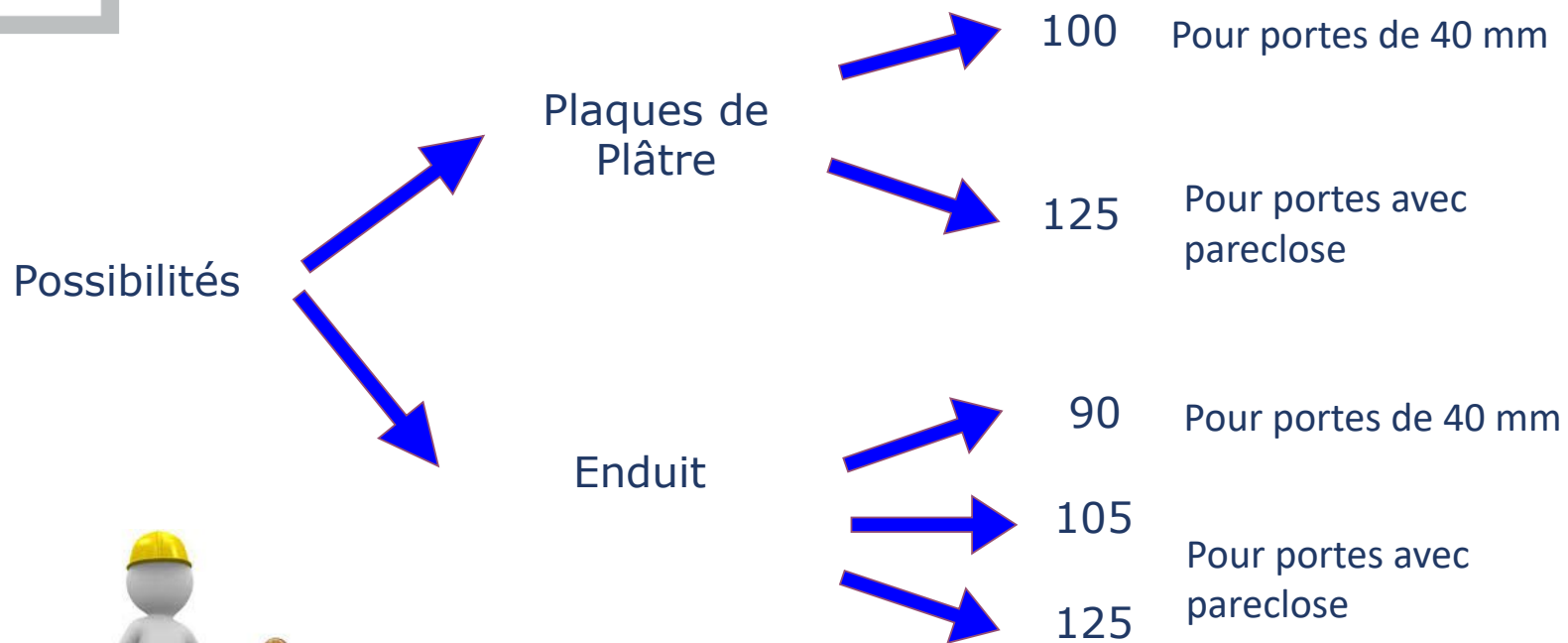

Sur demande : sur mesure en hauteur et largeur

Les produits Scigno

Les Accessoires

- Kit habillage 2en1
- Garnitures

KIT HABILLAGE INTEGRAL

Version : PRE' PEINT BLANC

1 V de L.600 à 1000mm

2 V de 1200 à 2400mm

H. montants fixes à 2040mm

Version plaque de plâtre 100 mm

Version enduit 90 mm





Kit chiudiscrigno - rond

Typologie

-  Avec serrure
-  Sans serrure
-  Clef articulée
-  Cylindre européen



Finitions

- Chromé brillant 
- Chromé satiné 
- Or brillant 
- Or satiné 

Kit chiudiscrigno - carré

Typologie



Avec serrure



Sans serrure



Clef articulée



Cylindre européen



Finition

Chromé brillant

Chromé satiné



Kit Chiudiscrigno

Bianc Ral 9016 gloss 25



Noir Ral 9005 gloss 25

