

**Ruote con supporto esterno / Roues avec support exterieur
Wheels with external support / Poleas con soporte superior**

Art. 386

Ruota con supporto esterno - 1 cuscinetto - Gola V

Roues avec support exterieur - 1 roulement à billes - Gorge V
Wheels with external support - 1 ball bearing - Groove V
Poleas con soporte superior - 1 rodamiento de bolas - Canal V

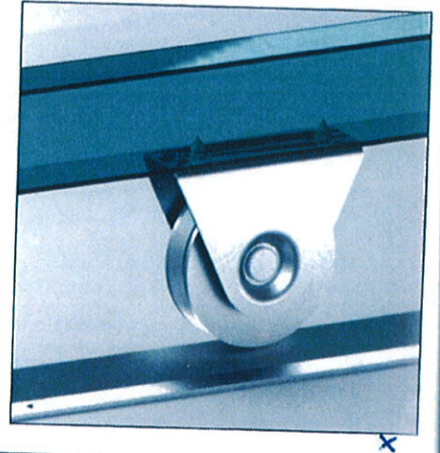
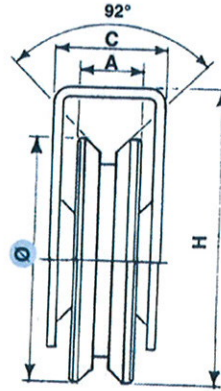
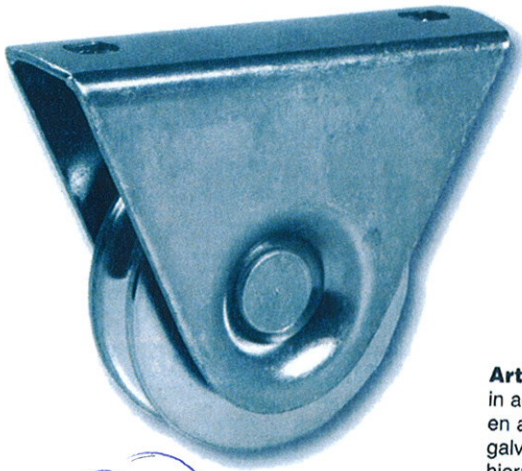

Art. 386
in acciaio zincato
en acier galvanisé
galvanized steel
hierro cingado

New
Art. 386/i
in INOX
da 80 e 100 mm

Fgw

Ø mm	50	60	70	80	90	100
A mm	17	17	20	20	20	20
C mm	28	28	37	37	37	37
H mm	58	63	90	95	100	105
Portata 2 ruote Force 2 roues Kg. Capacity 2 wheels Capacidad 2 poleas	120	150	200	300	300	350
CODICE ART.	386050	386060	386070	386080	386090	386100
N° Pcs	10	10	6	6	4	4
Kg.	4,500	5,500	4,500	5,400	4,400	5,200

Art. 385

Ruota con supporto esterno - 1 cuscinetto - Gola Tonda

Roues avec support exterieur - 1 roulement à billes - Gorge ronde
Wheels with external support - 1 ball bearing - Round groove
Poleas con soporte superior - 1 rodamiento de bolas - Canal redondo

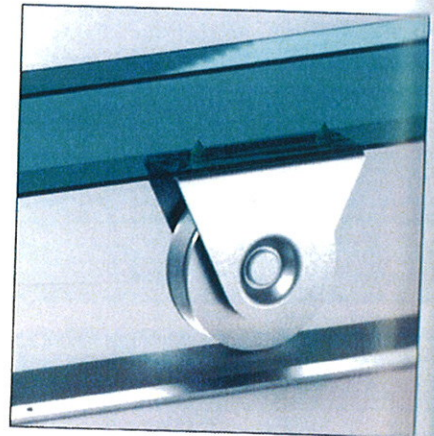
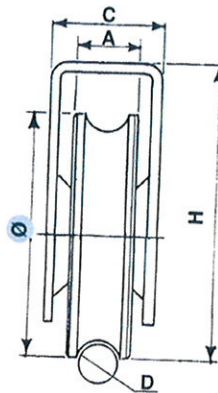
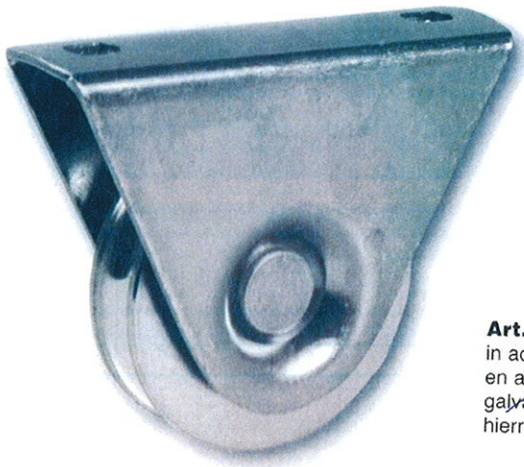

Art. 385
in acciaio zincato
en acier galvanisé
galvanized steel
hierro cingado

New
Art. 385/i
in INOX
da 80 e 100 mm

Ø mm	50	60	70	80	90	100
A mm	17	17	20	20	20	20
C mm	28	28	37	37	37	37
H mm	58	63	90	95	100	105
D mm	10	12	14	14	14	14
Portata 2 ruote Force 2 roues Kg. Capacity 2 wheels Capacidad 2 poleas	120	150	200	300	300	350
CODICE ART.	385050	385060	385070	385080	385090	385100
N° Pcs	10	10	6	6	4	4
Kg.	4,500	5,500	4,500	5,400	4,400	5,200

Accessori per serramenti e portoni industriali Acc. Industrial doors - Acc. Portails industriels - Acc. Portones industriales

Profilo zincato di 6mt a cementare filo pavimento

Art. 3026

 Galvanized profile 6 mt. long to be cemented into floor

 Profil zingué 6 mt. à cimenter au sol

 Guía en acero zincado a cementar bajo el nivel del suelo

NOVITA' 08

NOVAGUIDE

Materiale: Acciaio zincato

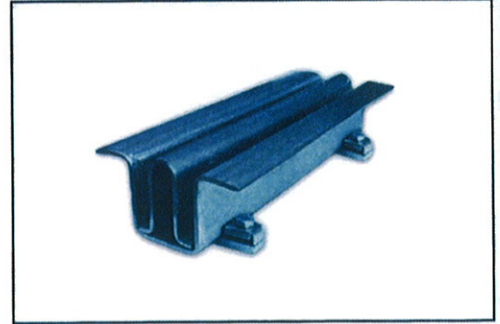
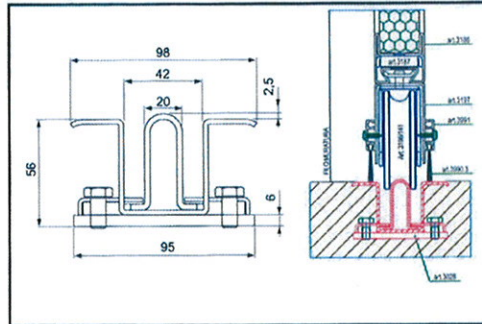
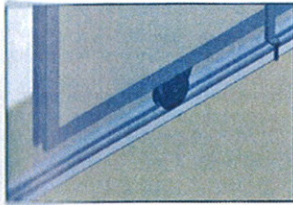



Art.	Peso(g/m)	Conf.
3026	6.550	20

Guida a cementare in acciaio zincato

Art. 3090

 Galvanized steel guide to be cemented

 Rail en acier zingué à cimenter

 Guía en acero cincado para cementar

NOVAGUIDE

Materiale: Acciaio zincato

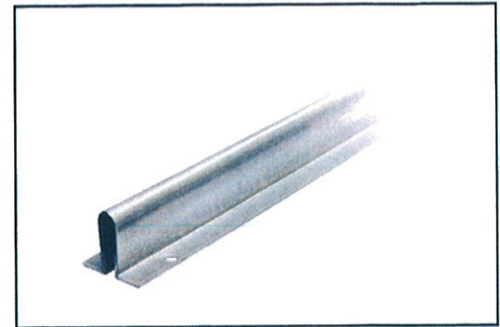
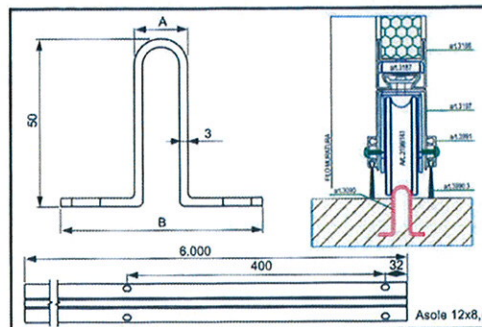
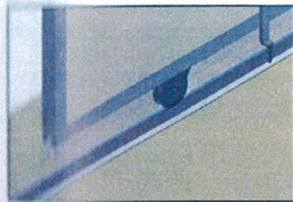

Art.	A	B	L	Peso/m	Conf.	€/m	Imb.
3090/20.3	20	60	3mt.	3.260	10	10,31	40
3090/20.6	20	60	6mt.	3.260	10	10,31	40

Guida ad avvitare in acciaio zincato

Art. 3091

 Galvanized steel guide to be screwed

 Rail en acier zingué à visser

 Guía en acero cincado para atornillar

NOVAGUIDE

Materiale: Acciaio zincato

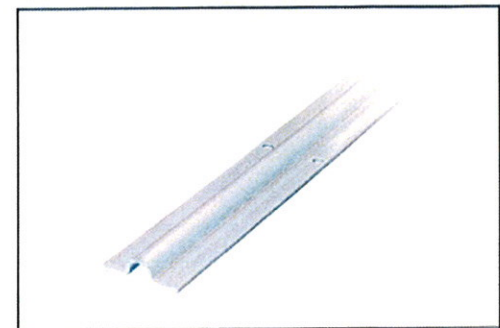
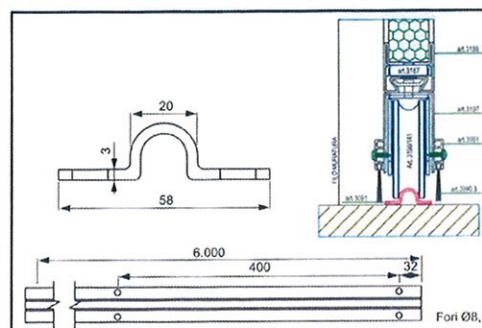
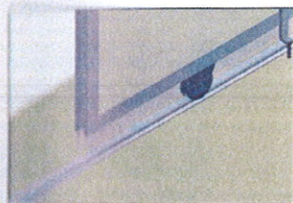

Art.	L/m	Peso/m	Conf.	€/m	Imb.	€/m
X 3091/20.3	3	1.600	10		40	
3091/20.6	6	1.600	10		40	