



Die unglasierten einfarbigen Feinsteinzeug-Bodenfliesen der Serie Taurus COLOR stehen für die hohe Qualität unserer Produktion. Kompromisslose Qualität, vielfältige Fliesenoberflächen und zusätzliches technisches Zubehör ermöglichen den Einsatz der Fliesen nicht nur in modernen, zeitlosen Innenräumen, sondern auch in Räumen, an die höhere Funktionsansprüche gestellt werden. Die Serie umfasst auch keramische Formstücke für Sehbehinderte und Blinde.

**„Unendliche Gestaltungsmöglichkeiten.“**



The highly sintered unglazed single-colour tiles of the Taurus COLOR series are the benchmark of our high level production. The uncompromising quality, variety of tile surfaces, and technical supplies allow the tiles to be used not only in modern, timeless interiors but also in spaces with higher functional requirements as well. The series also includes ceramic shaped bricks for the visually impaired and blind.











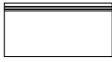
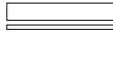



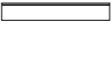
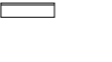





**„Unlimited design possibilities.“**

















Produkt   product								
EN 14411 - G Bla	Bodenfliese   floor tile	Bodenfliese   floor tile	Bodenfliese   floor tile	Bodenfliese   floor tile	Bodenfliese   floor tile mosaic sheet 30x30 cm	Mosaik sheet 30x30 cm   mosaic sheet 30x30 cm		
	60x60 <b>R</b>	30x60 <b>R</b>	30x30	20x20	10x10	5x5 <b>R</b>		
	598x598x10	298x598x10	298x298x9* 298x298x8**	198x198x9* 198x198x8**	98x98x9* 98x98x8**	48x48x9* 48x48x8**		
Oberfläche   surface	SF* ABS <b>NEWS</b>	SF* ABS <b>NEWS</b>	SRU*	SF* ABS <b>NEWS</b>	relief SR7	S* ABS <b>NEWS</b>	SF* ABS <b>NEWS</b>	
Rutschfestigkeit slip resistance	R9/A R10/B	R9/A R10/B	R10/B	R9/A R10/B	R11/B	R10/A R10/B	R10/B R10/B	
Reibungskoeffizient - trocken sliding friction coefficient - dry	$\mu \geq 0,6$	$\mu \geq 0,6$	$\mu \geq 0,6$	$\mu \geq 0,6$	$\mu \geq 0,7$	$\mu \geq 0,6$	$\mu \geq 0,6$	
Farbe   color								
<b>19 Black</b> schwarz   black	TAA61019* <b>TAK63019**</b> ○ 670   m <sup>2</sup>	TAASA019* <b>TAKSE019**</b> ○ 570   670   m <sup>2</sup>	TRUSA019* ○ 670   m <sup>2</sup>	TAA35019* <b>TAA34019**</b> ○ 430   m <sup>2</sup>	TR735019* <b>TR734019**</b> ○ 480   m <sup>2</sup>	TAA26019* <b>TAA25019**</b> ○ 480   m <sup>2</sup>	TAA12019* <b>TAA11019**</b> ○ 810   m <sup>2</sup>	TDM06019* <b>TDM05019**</b> ○ 390   Netz
<b>07 Dark Grey</b> dunkelgrau dark grey	TAA61007* <b>TAK63007**</b> ○ 670   m <sup>2</sup>	TAASA007* <b>TAKSE007**</b> ○ 570   670   m <sup>2</sup>	TRUSA007* ○ 670   m <sup>2</sup>	TAA35007* <b>TAA34007**</b> ○ 430   m <sup>2</sup>	TR735007* <b>TR734007**</b> ○ 480   m <sup>2</sup>	TAA26007* <b>TAA25007**</b> ○ 480   m <sup>2</sup>	TAA12007* <b>TAA11007**</b> ○ 810   m <sup>2</sup>	TDM06007* <b>TDM05007**</b> ○ 390   Netz
<b>06 Grey</b> grau   grey	TAA61006* <b>TAK63006**</b> ○ 560   m <sup>2</sup>	TAASA006* <b>TAKSE006**</b> ○ 540   560   m <sup>2</sup>	TRUSA006* ○ 560   m <sup>2</sup>	TAA35006* <b>TAA34006**</b> ○ 410   m <sup>2</sup>	TR735006* <b>TR734006**</b> ○ 460   m <sup>2</sup>	TAA26006* <b>TAA25006**</b> ○ 470   m <sup>2</sup>	TAA12006* <b>TAA11006**</b> ○ 810   m <sup>2</sup>	TDM06006* <b>TDM05006**</b> ○ 390   Netz
<b>03 Light Grey</b> hellgrau light grey	TAA61003* <b>TAK63003**</b> ○ 710   m <sup>2</sup>			TAA35003* <b>TAA34003**</b> ○ 430   m <sup>2</sup>	TR735003* <b>TR734003**</b> ○ 480   m <sup>2</sup>	TAA26003* <b>TAA25003**</b> ○ 480   m <sup>2</sup>	TAA12003* <b>TAA11003**</b> ○ 810   m <sup>2</sup>	TDM06003* <b>TDM05003**</b> ○ 390   Netz
<b>11 White</b> weiß   white	TAA61011* <b>TAK63011**</b> ○ 820   m <sup>2</sup>			TAA35011* <b>TAA34011**</b> ○ 620   m <sup>2</sup>		TAA26011* <b>TAA25011**</b> ○ 550   m <sup>2</sup>	TAA12011* <b>TAA11011**</b> ○ 850   m <sup>2</sup>	TDM06011* <b>TDM05011**</b> ○ 420   Netz
<b>10 Ivory</b> elfenbein   ivory	TAA61010* <b>TAK63010**</b> ○ 560   m <sup>2</sup>			TAA35010* <b>TAA34010**</b> ○ 410   m <sup>2</sup>	TR735010* <b>TR734010**</b> ○ 460   m <sup>2</sup>	TAA26010* <b>TAA25010**</b> ○ 470   m <sup>2</sup>	TAA12010* <b>TAA11010**</b> ○ 810   m <sup>2</sup>	TDM06010* <b>TDM05010**</b> ○ 390   Netz
<b>25 Tobacco</b> braun-grau brown-grey	TAA61025* <b>TAK63025**</b> ○ 670   m <sup>2</sup>			TAA35025* <b>TAA34025**</b> ○ 430   m <sup>2</sup>	TR735025* <b>TR734025**</b> ○ 480   m <sup>2</sup>	TAA26025* <b>TAA25025**</b> ○ 480   m <sup>2</sup>	TAA12025* <b>TAA11025**</b> ○ 810   m <sup>2</sup>	TDM06025* <b>TDM05025**</b> ○ 390   Netz
<b>logistische Daten   logistic information</b>								
	3	6		12   14	25   32	11   12	3   4	
	2,8	5,6		11,0   11,0	25,0   25,0	11,0   11,0	11,0   11,0	
	1,08	1,08		1,09   1,27	1,00   1,28	1,00   1,09	0,27   0,36	
	32	40		48   48	57   54	56   56	-	
	34,56	43,20		52,32   60,96	57,00   69,12	56,00   61,04	-	
	23,7	23,7		21,0   21,6	19,2   21,8	19,2   18,5	5,2   6,0	
	21,9	21,9		19,2   17,0	19,2   17,0	19,2   17,0	19,2   17,0	
	782	971		1 033   1 062	1 120   1 200	1 100   1 063	-	

\* Verfügbar solange der Vorrat reicht | Available while stocks last  
 \*\* Neues Produkt ab 05/2023 erhältlich | New product available from 05/2023

Produkt   product							
STO No. 030-059824	Stufe   step tile	Sicherheitsstufenprofil   step piece with riser	Spezielle keramische Formteile   special floor tile	Stufe   step tile	Socket   skirting plinth	Socket   skirting plinth	Socket   skirting plinth
	30×60 <b>R</b>	60×5 <b>R</b> 60×2	30×30	30×30	60×9,5 <b>R</b>	30×8	
	298×598×10	598×50×10 598×20×10	298×298×9	298×298×9* 298×298×8**	598×95×10	298×80×9* 298×80×8**	
Oberfläche   surface	SF* ABS 	SF* ABS 	relief go relief stop	SF* ABS 	SF* ABS 	S* ABS 	
Rutschfestigkeit slip resistance	R9/A R10/B	R9/A R10/B	R11/A	R11/A	R9/A R10/B		
Reibungskoeffizient - trocken sliding friction coefficient - dry	μ ≥ 0,7	μ ≥ 0,7	μ ≥ 0,7	μ ≥ 0,7	μ ≥ 0,7		
Farbe   color							
19 Black schwarz   black	TCPSA019* TCPSE019** ○ 370   St	TCPVD019* TCPVNO19** ○ 530   set	TTG35019 ○ 500   St	TTS35019 ○ 500   St	TCP35019* TCP34019** ○ 170   St	TSAS4019* TSASZ019** ○ 220   St	TSAJB019* TSAKF019** ○ 140   St
07 Dark Grey dunkelgrau   dark grey	TCPSA007* TCPSE007** ○ 370   St				TCP35007* TCP34007** ○ 170   St	TSAS4007* TSASZ007** ○ 220   St	TSAJB007* TSAKF007** ○ 140   St
06 Grey grau   grey	TCPSA006* TCPSE006** ○ 370   St				TCP35006* TCP34006** ○ 170   St	TSAS4006* TSASZ006** ○ 220   St	TSAJB006* TSAKF006** ○ 140   St
03 Light Grey hellgrau   light grey	TCPSA003* TCPSE003** ○ 370   St				TCP35003* TCP34003** ○ 170   St	TSAS4003* TSASZ003** ○ 220   St	TSAJB003* TSAKF003** ○ 140   St
11 White weiß   white	TCPSA011* TCPSE011** ○ 390   St				TCP35011* TCP34011** ○ 180   St	TSAS4011* TSASZ011** ○ 250   St	TSAJB011* TSAKF011** ○ 150   St
10 Ivory elfenbein   ivory	TCPSA010* TCPSE010** ○ 370   St	TCPVD010* TCPVNO10** ○ 530   set	TTG35010 ○ 500   St	TTS35010 ○ 500   St	TCP35010* TCP34010** ○ 170   St	TSAS4010* TSASZ010** ○ 220   St	TSAJB010* TSAKF010** ○ 140   St
25 Tobacco braun-grau   brown-grey	TCPSA025* TCPSE025** ○ 370   St				TCP35025* TCP34025** ○ 170   St	TSAS4025* TSASZ025** ○ 220   St	TSAJB025* TSAKF025** ○ 140   St
logistische Daten   logistic information							
	6	16	9	11   13	13	21   23	
	5,6	-	11,0	11,0   11,0	17,5	42,0   42,0	
	1,08	-	0,81	1,00   1,18	0,74	0,50   0,55	
	40	-	42	52   52	-	-	
	43,20	-	34,36	52,00   61,36	-	-	
	23,7	15,2	18,0	19,2   19,5	16,2	9,5   9,4	
	21,9	21,9	22,2	19,2   17,0	21,9	19,0   17,0	
	971	-	780	1 024   1 039	-	-	

\* Verfügbar solange der Vorrat reicht | Available while stocks last  
 \*\* Neues Produkt ab 05/2023 erhältlich | New product available from 05/2023

							
Hohlkehlssocket   cove skirting	Hohlkehlssocket   cove skirting	Innenecke Hohlkehlssocket   inside corner cove skirting	Außenecke Hohlkehlssocket   outside corner cove skirting	Innenecke Hohlkehlssocket   inside corner cove skirting	Außenecke Hohlkehlssocket   outside corner cove skirting	Duschtasseneckstein   shower piece corner	Duschtassenstein   shower piece continuous
30×8	20×9 20×8	2,3×8	2,3×8	2,3×9	2,3×9	10×10	10×10
298×80×9* 298×80×8**	198×90×9* 198×80×8**	80×23×10	80×23×7	90×23×10	90×23×7	98×98×8	98×98×8
S* ABS 	S* ABS 	S	S	S*	S*	SB* ABS 	SB* ABS 
R10/B	R10/B					R10/B	R10/B
μ ≥ 0,6	μ ≥ 0,6					μ ≥ 0,6	μ ≥ 0,6
TSPJB019* TSPKF019** ○ 140   St	TSPEM019* TSPF6019** ○ 120   St	TSIRH019 ○ 200   St	TSERH019 ○ 200   St	TSIRB019* ○ 200   St	TSERB019* ○ 200   St	TTR12019* TTR11019** ○ 200   St	TTP12019* TTP11019** ○ 200   St
TSPJB007* TSPKF007** ○ 140   St	TSPEM007* TSPF6007** ○ 120   St	TSIRH007 ○ 200   St	TSERH007 ○ 200   St	TSIRB007* ○ 200   St	TSERB007* ○ 200   St	TTR11007* TTR11007** ○ 200   St	TTP12007* TTP11007** ○ 200   St
TSPJB006* TSPKF006** ○ 140   St	TSPEM006* TSPF6006** ○ 120   St	TSIRH006 ○ 200   St	TSERH006 ○ 200   St	TSIRB006* ○ 200   St	TSERB006* ○ 200   St	TTR12006* TTR11006** ○ 200   St	TTP12006* TTP11006** ○ 200   St
TSPJB003* TSPKF003** ○ 140   St	TSPEM003* TSPF6003** ○ 120   St	TSIRH003 ○ 200   St	TSERH003 ○ 200   St	TSIRB003* ○ 200   St	TSERB003* ○ 200   St	TTR12003* TTR11003** ○ 200   St	TTP12003* TTP11003** ○ 200   St
TSPJB010* TSPKF010** ○ 140   St	TSPEM010* TSPF6010** ○ 120   St	TSIRH010 ○ 200   St	TSERH010 ○ 200   St	TSIRB010* ○ 200   St	TSERB010* ○ 200   St	TTR12010* TTR11010** ○ 200   St	TTP12010* TTP11010** ○ 200   St
TSPJB025* TSPKF025** ○ 140   St	TSPEM025* TSPF6025** ○ 120   St	TSIRH025 ○ 200   St	TSERH025 ○ 200   St	TSIRB025* ○ 200   St	TSERB025* ○ 200   St	TTR12025* TTR11025** ○ 200   St	TTP12025* TTP11025** ○ 200   St
21   19	22   28	150	100	150	100	16	16
42,0   42,0	55,0   62,5	-	-	-	-	100,0	100,0
0,50   0,46	0,40   0,45	-	-	-	-	0,16	0,16
-	-	-	-	-	-	-	-
-	-	-	-	-	-	-	-
9,5   7,8	7,7   7,6	4,5	3,5	4,5	3,5	3,5	3,2
19,0   17,0	19,2   17,0	-	-	-	-	-	-
-	-	-	-	-	-	-	-



Farben | colors

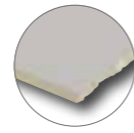

19 Black  
schwarz | black



07 Dark Grey  
dunkelgrau | dark grey



06 Grey  
grau | grey

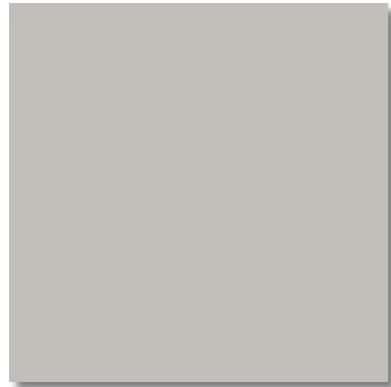

03 Light Grey  
hellgrau | light grey

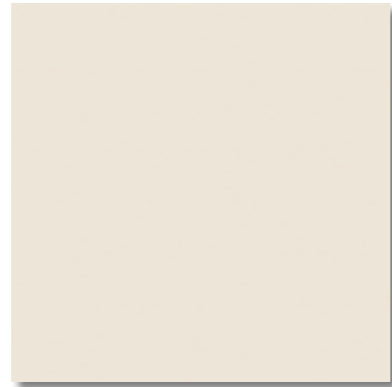

11 White  
weiß | white

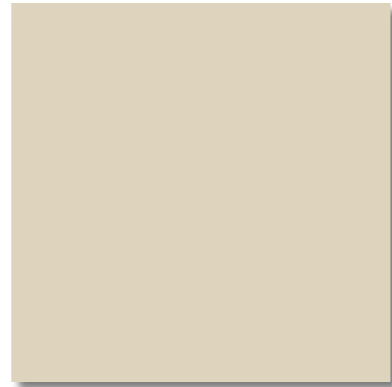

10 Ivory  
elfenbein | ivory



25 Tobacco  
braun-grau | brown-grey



Oberflächen | surfaces

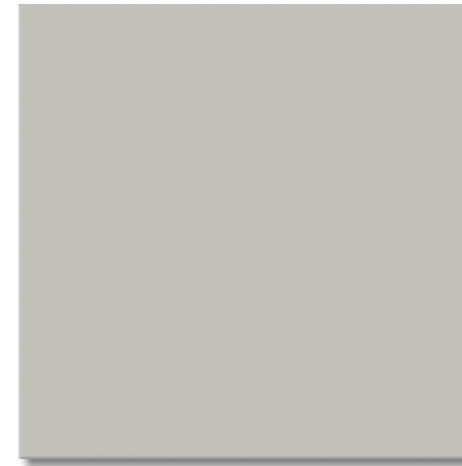

S | SF\* R9/A - R10/B  
 $\mu \geq 0,6 - 0,7$



SB\* R10/B  
 $\mu \geq 0,7$

ABS\*\* R10/B  
 $\mu \geq 0,6$  **News**



SRU\* R10/B  
 $\mu \geq 0,7$



relief SR7 R11/B  
 $\mu \geq 0,7$

S... - Standardoberfläche | Standard surface  
SF... - Standardoberfläche fixiert | Standard surface fixe  
ABS... - Glatte rutschhemmende Oberfläche R10/B | Smooth slip-resistant surface R10/B  
SB... - Glatte rutschhemmende Oberfläche fixiert | Smooth slip-resistant surface fixed  
SR... - Reliefoberfläche | Relief surface

\* Verfügbar solange der Vorrat reicht | Available while stocks last

\*\* Neues Produkt ab 05/2023 erhältlich | New product available from 05/2023



Formteile | special pieces

**Stufe** | step tile | TCPSA... | 298×598×10 mm\*

**TCPSE...** | 298×598×10 mm\*\* |

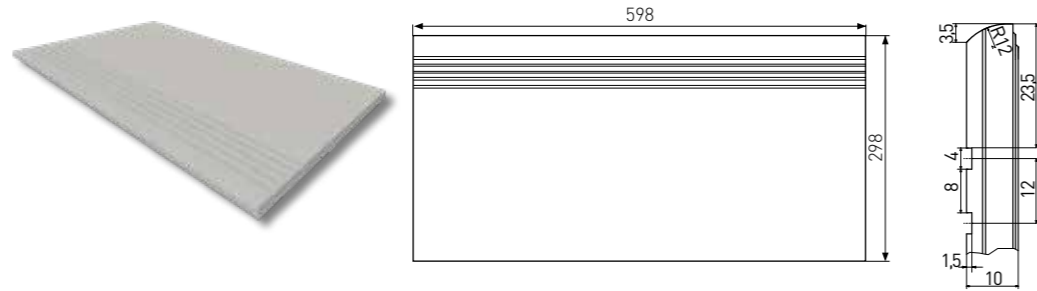

**Stufe** | step tile | TCP35... | 298×298×9 mm\*

**TCP34...** | 298×298×8 mm\*\* |

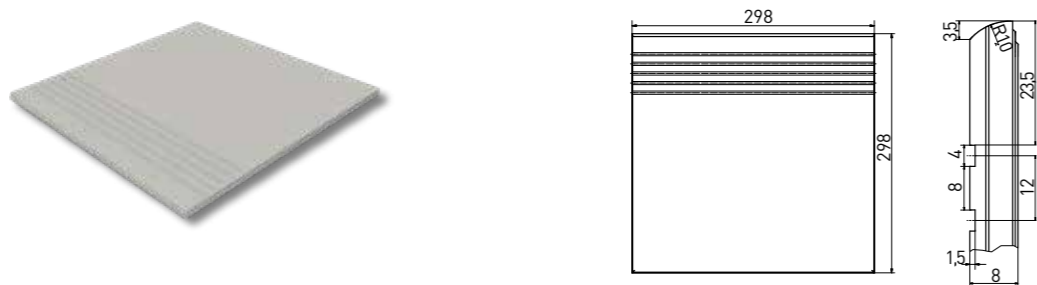

**Socket** | skirting plinth | TSAS4... | 598×95×10 mm\*

**TSASZ...** | 598×95×10 mm\*\* |

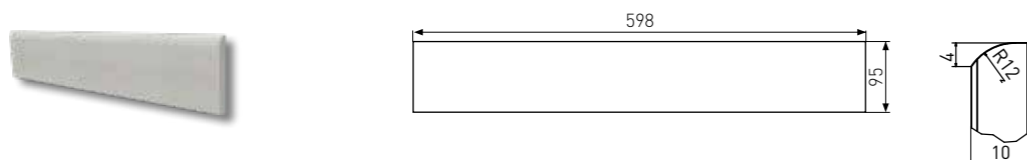

**Socket** | skirting plinth | TSAJB... | 298×80×9 mm\*

**TSAKF...** | 298×80×8 mm\*\* |

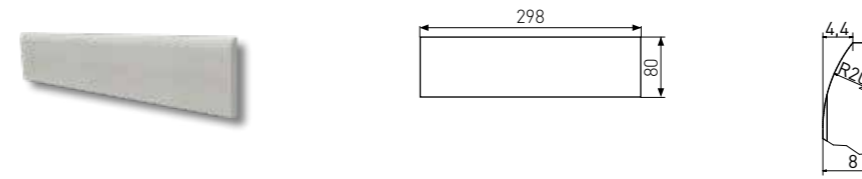

**Hohlkehsocket** | cove skirting | TSPJB... | 298×80×9 mm\*

**TSPKF...** | 298×80×8 mm\*\* |

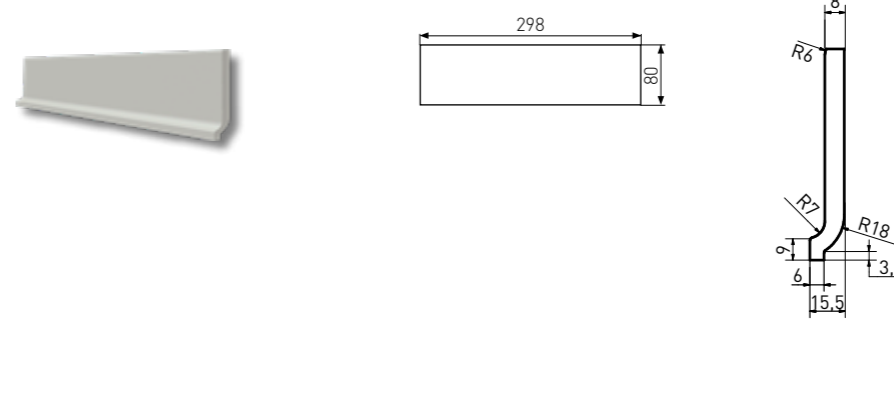

**Hohlkehsocket** | cove skirting | TSPEM... | 198×90×9 mm\*

**TSPF6...** | 198×80×8 mm\*\* |

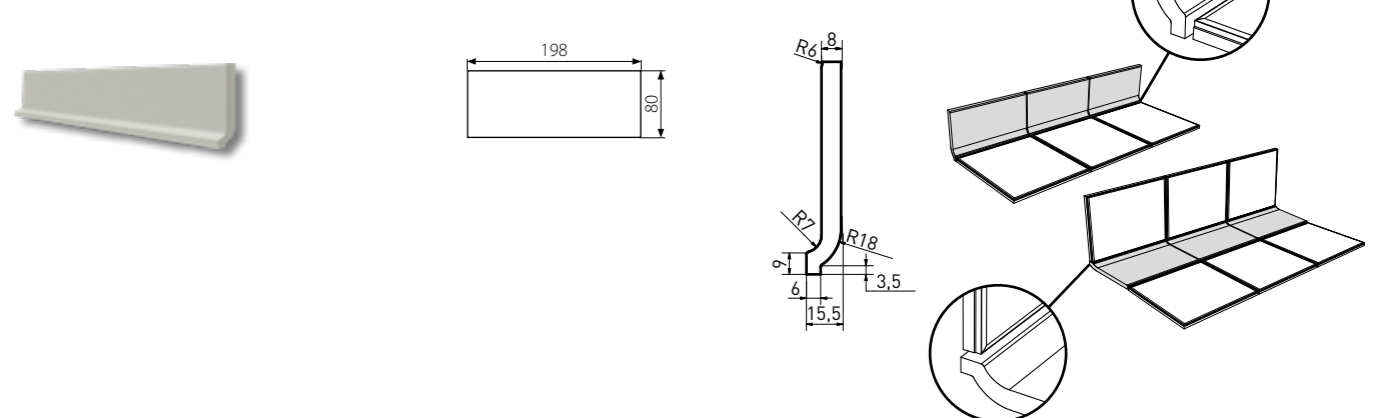

\* Verfügbar solange der Vorrat reicht | Available while stocks last

\*\* Neues Produkt ab 05/2023 erhältlich | New product available from 05/2023



Formteile | special pieces



**Innenecke Hohlkehlssockel** | inside corner cove skirting | TSIRH... | 23x80x10 mm

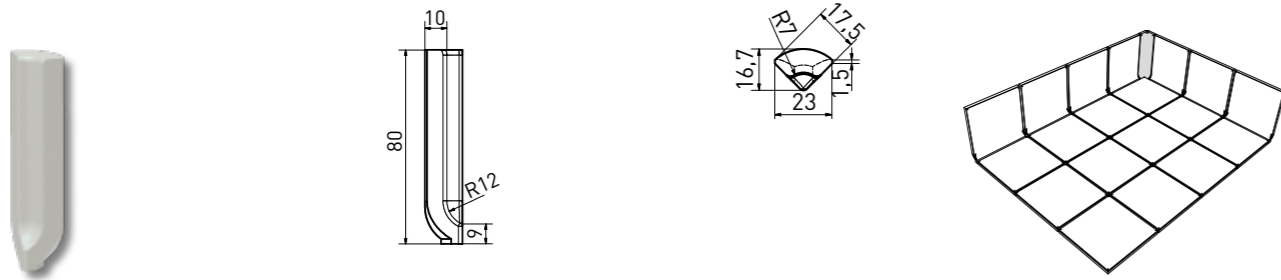

**Außenecke Hohlkehlssockel** | outside corner cove skirting | TSERH... | 23x80x7 mm

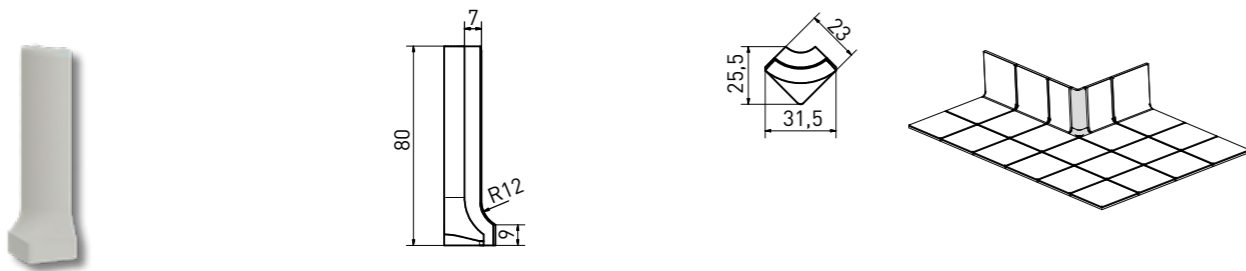

**Innenecke Hohlkehlssockel** | inside corner cove skirting | TSIRB... | 23x90x10 mm\*

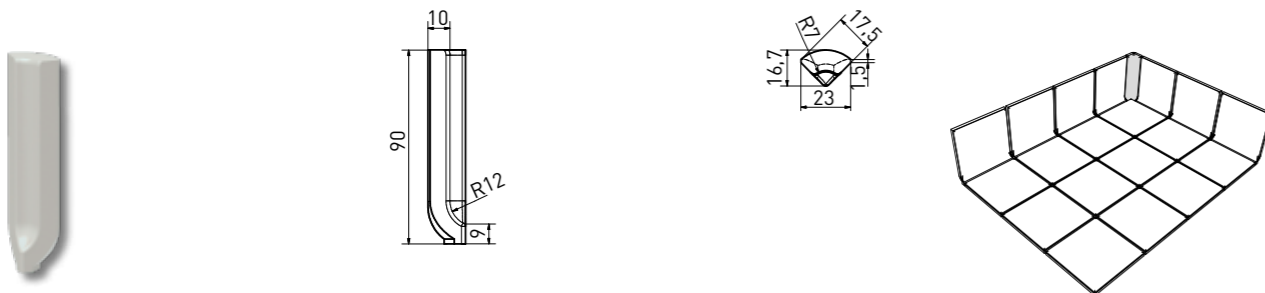

**Außenecke Hohlkehlssockel** | outside corner cove skirting | TSERB... | 23x90x7 mm\*

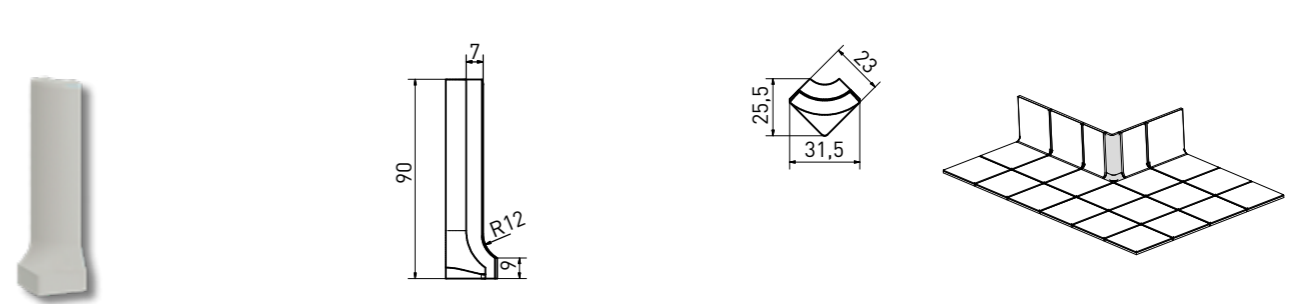

**Duschtasseneckstein** | shower piece - corner | TTR12... | 98x98x8 mm\*

**TTR11... | 98x98x8 mm\*\*** |

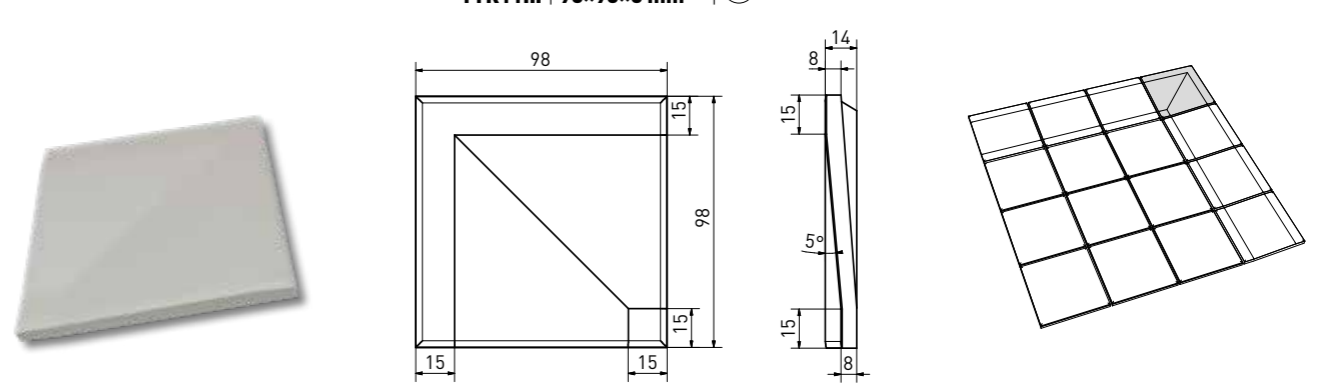

**Duschtassenstein** | shower piece - continuous | TTP12... | 98x98x8 mm\*

**TTP11... | 98x98x8 mm\*\*** |

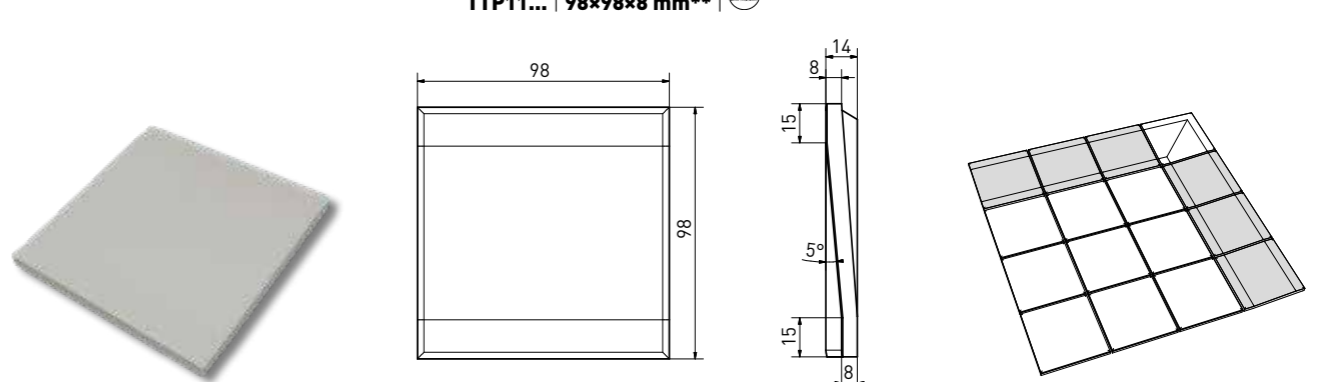

\* Verfügbar solange der Vorrat reicht | Available while stocks last

\*\* Neues Produkt ab 05/2023 erhältlich | New product available from 05/2023





**Sicherheitsstufenprofil** | step piece with riser | TCPVD... | 598x50x10 mm | 598x20x10 mm\*

**TCPVN... | 598x50x10 mm | 598x20x10 mm\*\*** |

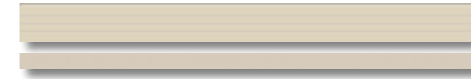

TCPVD010\*  
TCPVN010\*\*



TCPVD019\*  
TCPVN019\*\*

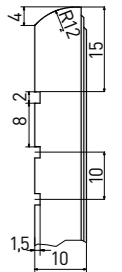
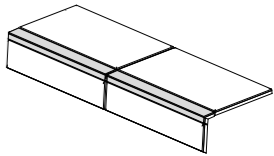
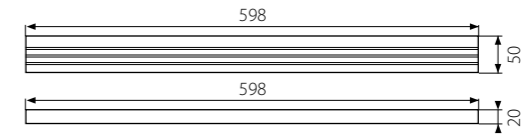

**Spezielle keramische Formteile für Sehschwache und Blinde** | special ceramic shaped tiles for the visually impaired persons

relief go



TTG35010



TTG35019

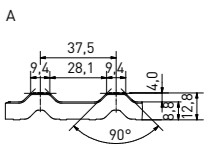

relief stop

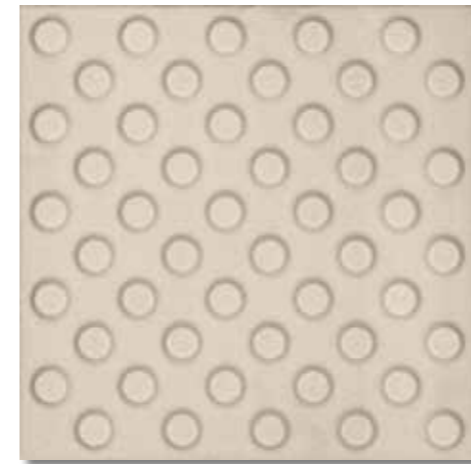

TTS35010

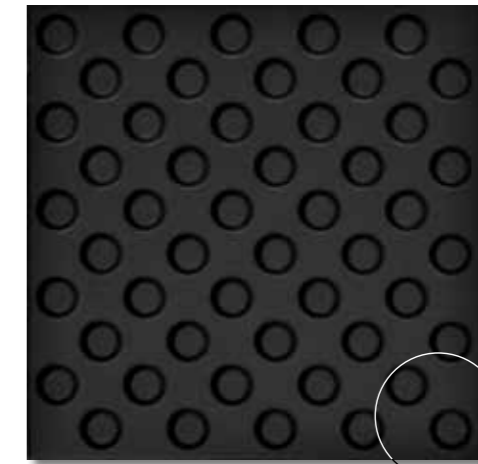

TTS35019

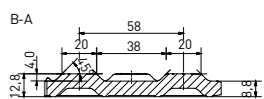
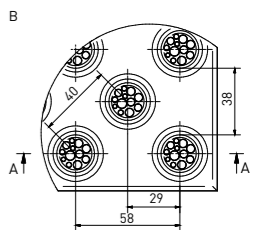

elfenbein | ivory

schwarz | black

\* Verfügbar solange der Vorrat reicht | Available while stocks last

\*\* Neues Produkt ab 05/2023 erhältlich | New product available from 05/2023