

Paslode® Impulse®

IM90Xi - IM100Xi

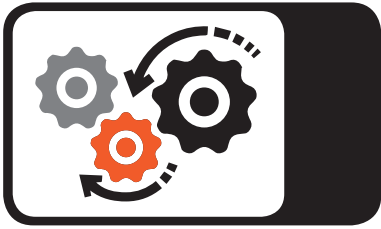



IM90Xi

Ø = 2.5 > 3.1 mm
 L = 50 > 90 mm (Smooth & Ring)
 RounDrive®
 34°

IM100Xi

Ø = 2.8 > 3.4 mm
 L = 63 mm Ring
 98 mm Uniloc
 100 mm Smooth

RounDrive®
 34°

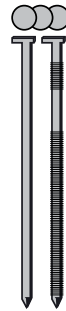

	15 min.	2 500 max.
	60 min.	10 000 max.
	90 min.	13 000 max.



25%	50%	75%	100%
○	○	○	○
●	●	●	●

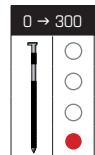



-15°C	IM90Xi / IM100Xi : 1 000 /hour
≤ T ≤	IM90Xi : 4 000 /day
+49°C	IM100Xi : 3 000 /day



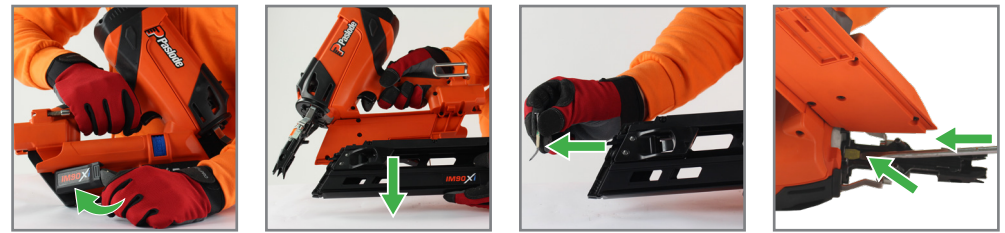
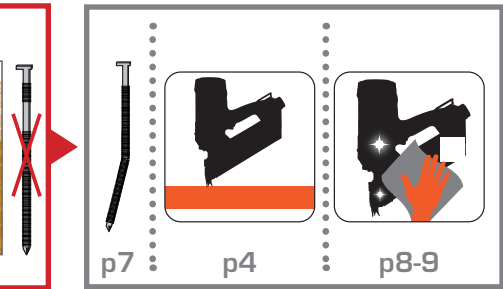
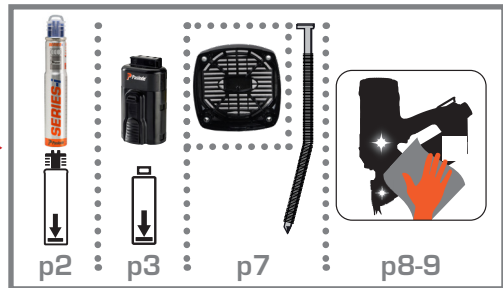

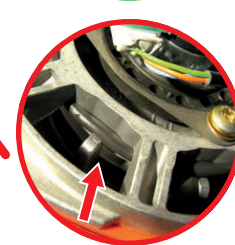
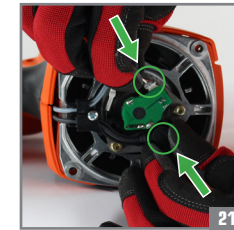
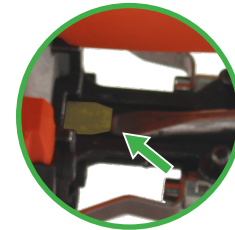
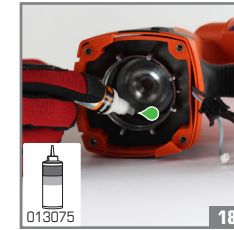
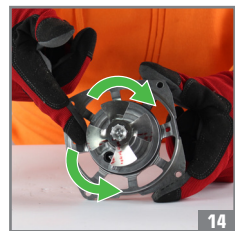
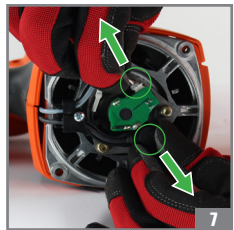

RESET



Resting position / Ruheposition / Position de repos / Ruststand / Posición de descanso / Posizione di riposo / Posição de descanso / Pozycja spoczynku / Klidová poloha / Nyugalmi állapot / Положение в нерабочем состоянии / Θέση αδράνειας / Hvilestilling / Viloläge / Hvileposisjon / Leroasento / Položaj mirovanja / Pokojová poloha / Položaj mirovanja / وضع السكون / Ramybės padėtis / Ooteasend / Miera stāvoklis / Hvíldarstaða

Notes

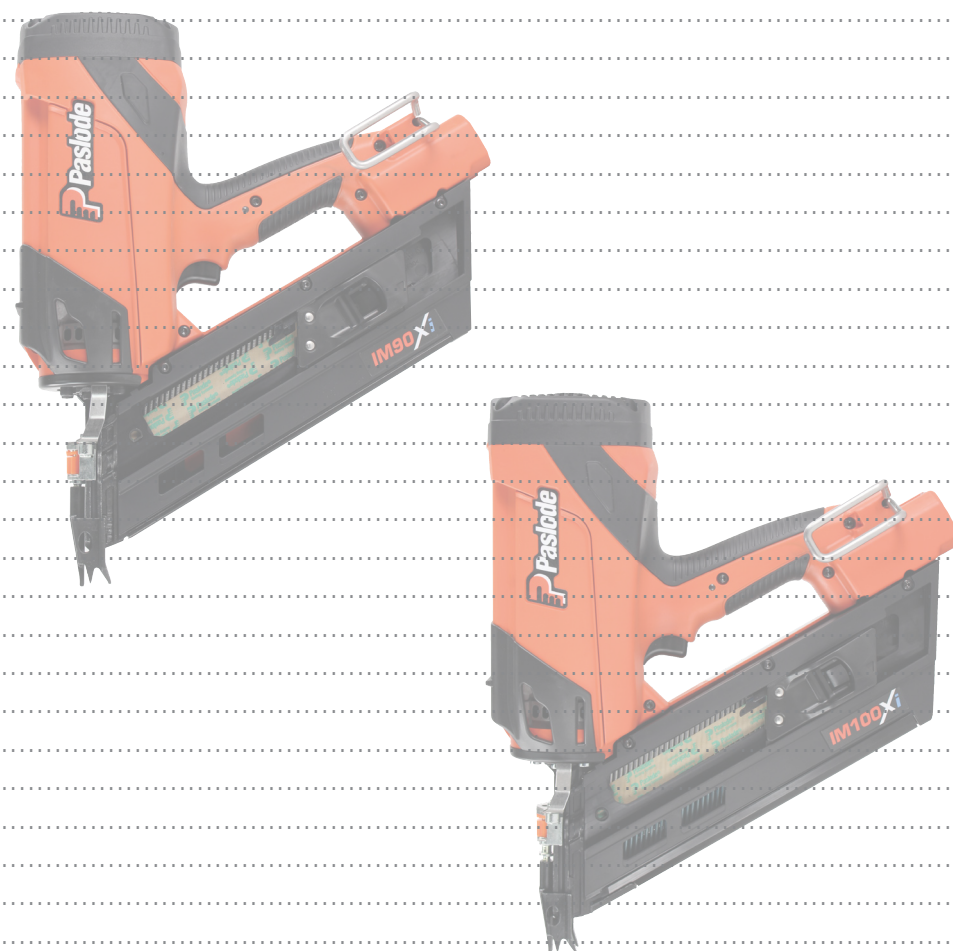



ON



OFF



IM90Xi

Ø = 2,5 > 3,1 mm
 L = 50 > 90 mm (Smooth & Ring)
 RounDrive®
 34°

IM100Xi

Ø = 2,8 > 3,4 mm
 L = 63 mm Ring
 98 mm Uniloc
 100 mm Smooth
 RounDrive®
 34°

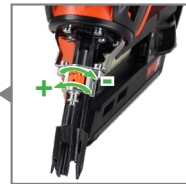

Route de Lyon F-26500 Bourg-lès-Valence

019690-1
 02/2020